

# Vino Series Post System with Hidden Brackets

Installation guide for Vino Series Post with FCP-HID Brackets



## 3D INTERACTIVE INSTRUCTIONS

USE BILT TO ASSEMBLE WITH CONFIDENCE

For fast 3D step-by-step instructions,  
download the free BILT app!



Available on most iOS and Android Devices

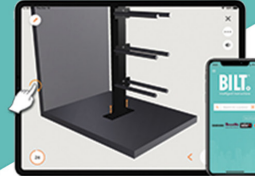

**BILT.**  
Intelligent Instructions

### Included:

- (1) Hidden Bracket
- (1) Drill Bit
- (2) Self Drilling Screws

### Additional Components:

*(sold separately)*

- (1) 62" Post Bottom (c-Channel)
- (1) 62" Post Top
- (1) Post (Top or Bottom)\*
- 96 Mounting Plate screws
- Vino Series Post Mounting Plates with Self-Drilling Screws
- Vino Pins or Vino Rails

### Required Tools:

- Drill
- Phillips head drill bit
- Phillips head screwdriver
- Level
- Pencil or Marker
- Tape measure
- Metal cutting saw
- Metal file
- Square
- Rubber Mallet (optional)

### Important Note:

These installation instructions will assist you with installing the VintageView Vino Series Post System with Hidden Brackets to allow for a more minimalist design on installations of up to 120" (3048mm). Hidden Brackets are also commonly used to create Elbow Standoff Extensions in conjunction with an Elbow. Reference instructions for VS-FCP-ELB for details.

### Fasteners:

Fasteners for securing Mounting Plates to the Vino Series Posts are provided (self-drilling screws). Each mounting Plate is pre-drilled for installing Post. When installing finished Vino Series Post to the floor or ceiling, please use the following recommendations for fasteners:

### Guidelines for Floor/Ceiling Hardware

**Wood/Stud:** #8 x 1-1/4" course thread screws (or longer)

**Concrete, Brick, or Stucco:** 3/16" x 1-1/4" masonry screw  
or #8 x 1- 1/4" screw with appropriate size expanding anchor

**Drywall:** Expanding hollow wall anchors with at least #8 screw size



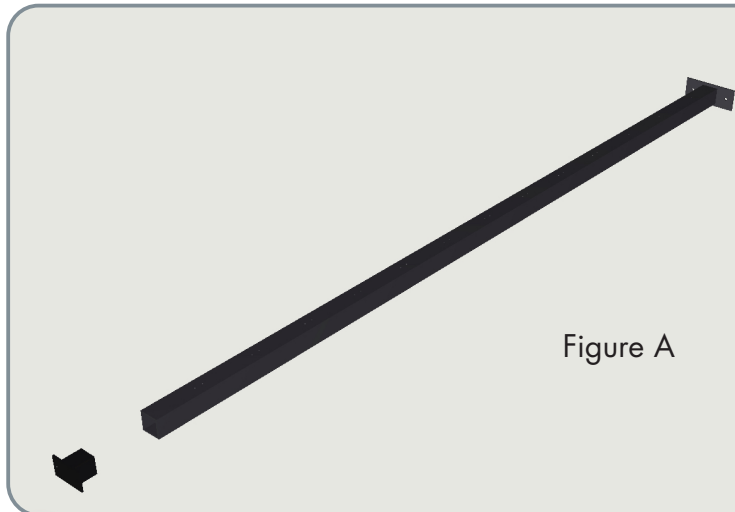

Figure A

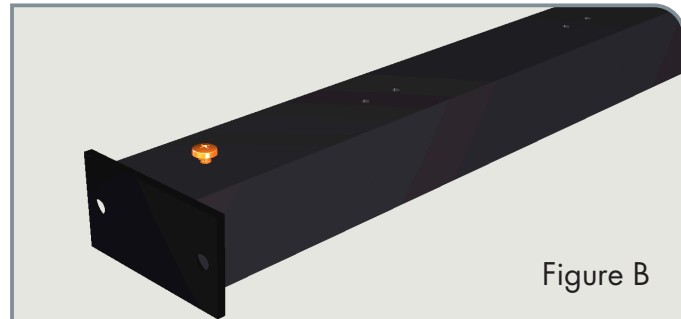

Figure B



Figure C

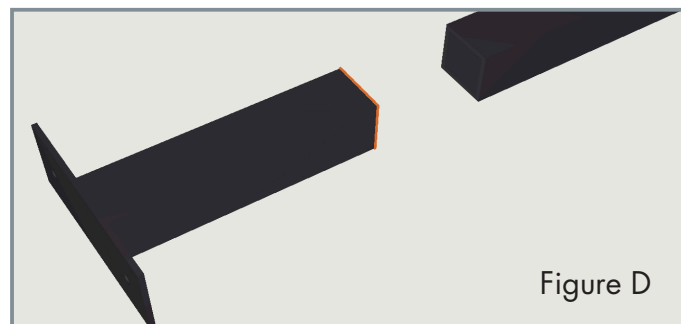

Figure D

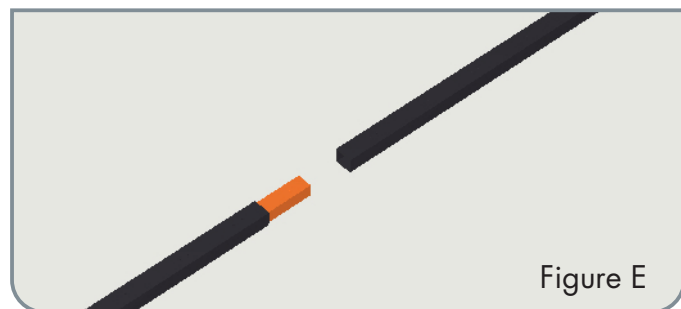

Figure E

## 1. IDENTIFY PROPER HARDWARE

Using the chart on the previous page, identify the proper floor/ceiling hardware (not included) that will be needed for your specific project. For drywall surfaces in floor or ceiling, VintageView recommend installing to joists or wood backing when available.

## 2. MEASURE

Measure the desired location's ceiling height.

## 3. CUT THE POST BOTTOM

*Optional if using a Hidden on both ends of the Post (most common).* Using a Metal Cutting Saw, squarely cut off the welded Mounting Bracket from the Post Bottom (Figure D). *Do not use abrasive saws as they may damage the finish.*

## 4. INSERT HIDDEN BRACKET

Insert the Hidden Bracket into the Post Top (Figure A). A Rubber Mallet may be needed to connect fully. Repeat step on cut end of Post Bottom.

## 5. SECURE THE BRACKETS

Using the provided Drill Bit, drill through Post and Bracket, ensuring drill hole passes through one of three sides of the Hidden's c-channel. Thread provided Screw to secure the Post and Hidden Brackets (Figure B).

## 6. MARK THE POST

Lay the Post Top section, welded Mounting Bracket side down, next to the Post Bottom, interlaced (Figure C). Position the two sections so that the measurement from top to bottom of the base plates equals your ceiling height.

Use a pencil or marker to mark any overlap on the bottom of the Post Top.

Do not mark/cut from the end with C-Channel.

## 7. CUT THE POST

Using a Metal Cutting Saw, squarely cut off the welded Mounting Bracket from the Post Top section at the mark (Figure D). *Do not use abrasive saws as they may damage the finish.*



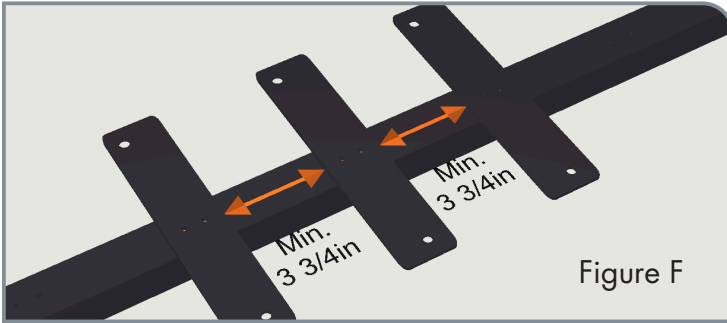

Figure F

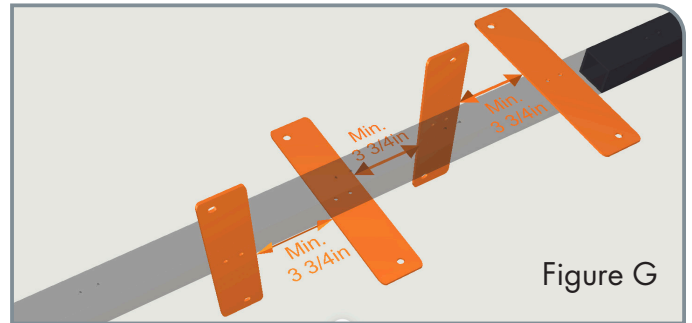

Figure G

## 8. CONNECT THE POST

Slide the Post Top Section onto the C-Channel in the Post bottom (Figure E, previous page). It may require a Rubber Mallet to connect fully.

## 9. MARK MOUNTING HOLES

Place the Post in the desired location. Ensure it is plumb with a level and mark the mounting holes on the ceiling, wall, and floor. Set the Post aside and drill any required pilot holes based on floor and ceiling mounting hardware selections.

## 10. MARK MOUNTING PLATE HOLES

Lay the first Mounting Plate in the desired location on the Post. Mark two (2) mounting hole locations. Mark the holes for the next Plate ensuring a minimum of 3-3/4" vertical clearance from one Plate to the next (Figure G). Use a Level and a Square to ensure Plates are Level. Set the plate to the side.

*NOTE: Plates can be installed to 1, 2, 3, or 4 sides of the Post. If consecutive Plates are assembled on adjacent sides, a minimum of 3-3/4" (96mm) vertical clearance is required (Figure G).*

## 11. PRE-DRILL MOUNTING HOLES

Using the provided Drill Bit, pre-drill all marked mounting hole locations.

## 12. ASSEMBLE AND THE PLATES

### For Vino Pins

Mounting Plates are sold in two unique widths: one for standard 750ml or Champagne bottles and one for magnum 1.5L bottles.

*(Optional) Assemble the Vino Pins and Vino Pins Extensions (Figure H) to reach desired bottle depth (up to 3 bottles deep for 750ml bottles and up to 2 bottles deep, with spacer, for Magnum bottles).*

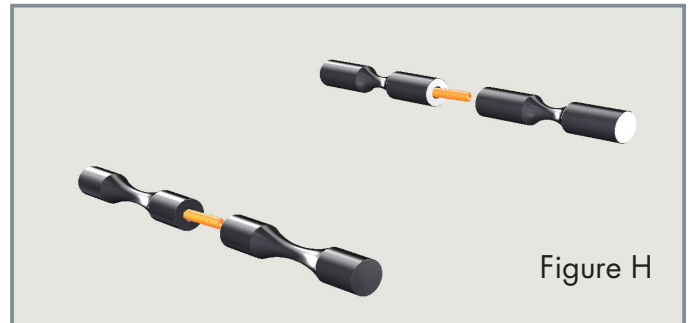

Figure H

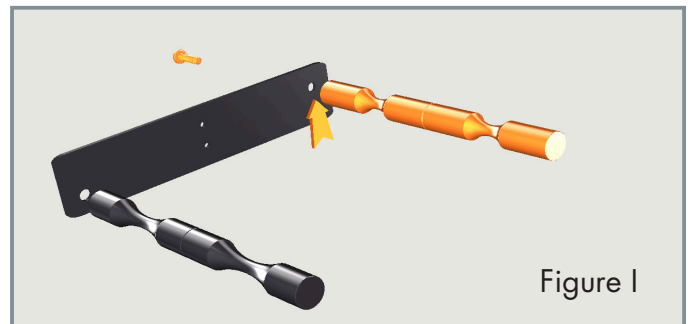

Figure I

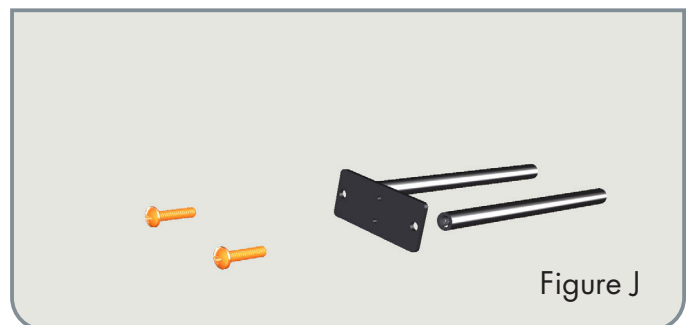

Figure J

Fasten the Vino Pins to the Mounting Plates using provided M6 Screws (Figure I). Ensure the higher mounting hole in the Mounting Plate points in the direction you want the bottle neck to face. Fasten the Vino Pins Neck (slimmer bottle impression) piece to the higher of the two holes.



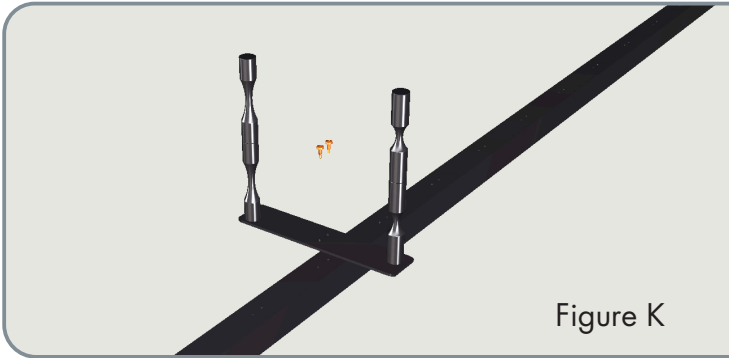

Figure K

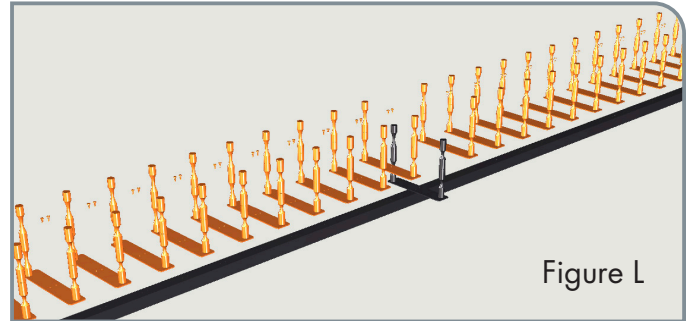

Figure L

## For Vino Rails

Mounting Plates are sold in standard 750ml or Champagne bottles and magnum 1.5L bottles configurations, each with choice of single, double, or triple bottle width. Thread all Vino Rails to the Mounting Plates using the provided M6 Screws (Figure J, previous page).

*NOTE: If installing Vino Rails Magnum wine racks, do not insert supplied Bridge until the entire installation is finished.*

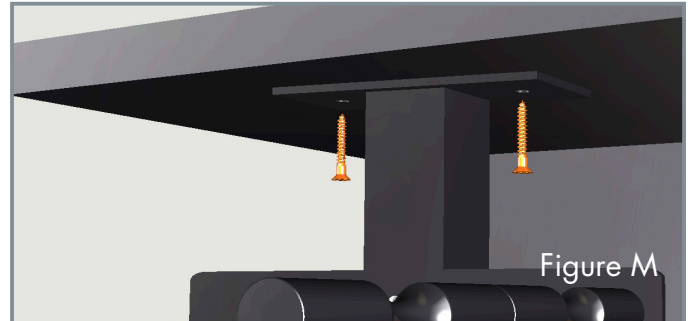

Figure M

## 13. INSTALL THE PLATES

Attach one (1) assembled Mounting Plate to the Post using two (2) provided Self-Drilling Screws into the pre-drilled holes (Figure K). Repeat the previous step to attach the remaining Mounting Plate assemblies (Figure L).

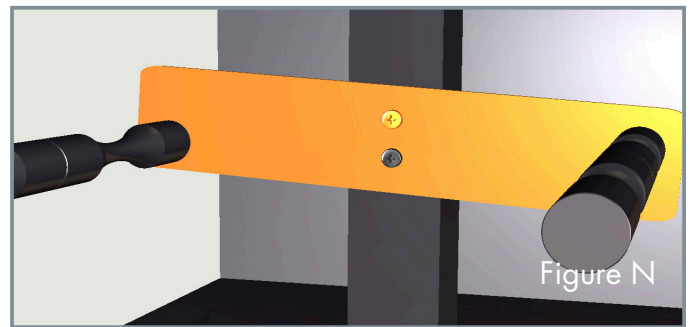

Figure N

## 14. INSTALL THE SYSTEM

Stand the Post Assembly in the desired location and ensure it is plumb both front and back and side-to-side with a level. Mark mounting holes on floor, ceiling, and wall. Set Post aside and pre-drill mounting holes.

Place Post back in place, ensuring it is level, and secure to the ceiling (Figure M) using two (2) of the appropriate fasteners (not provided). Double check the Post is plumb and secure the Post to the floor and wall using two (2) of the appropriate fasteners (not provided) at each location.

If any of the Mounting Plates appear unlevel, loosen one (1) Screw slightly and reposition using a Rubber Mallet and Level (Figure N). Re-tighten the screw.

## 11. ADD WINE

Only the good stuff.

## Problems?

Try using BILT 3D intelligent instructions, visit [www.vintageview.com](http://www.vintageview.com) or call 303-504-9463.

## Maintenance and Care:

Vino Pins or Rails should be regularly checked for tightness. Should any rack to be found to be loose, tighten by hand until secure.

All components of the Vino Series Post System may be cleaned with a damp cloth and mild dish soap -abrasive pads or steel wool should NOT be used as they will damage the finished surfaces of the parts.

SCAN FOR BILT. 3D INSTRUCTIONS



POWERED BY BILT INTELLIGENT INSTRUCTIONS\*

