

CLASSIC AND EXCLUSIVE SERIES - Specification Guide

Installation Type :: Wall Mount (Classic) and Floor-to-ceiling (Exclusive) | Display Options :: P1, P2, P3, MP1, MP2, LS | Colour Options :: 13 Colours available | Capacity :: Based on configuration | Pricing :: Based on configuration

Classic Series (Wall-mount) and **Exclusive Series** (Floor-to-ceiling) are available in custom configured heights from min. 12" (304.8mm) to max. 120" (3048mm).

Modular components consist of regular bottle holders (1, 2 and 3 deep), magnum sized bottle holders (1 and 2 deep) as well as LED light display shelves (LS). A combination of any of standard components and colours can make up single or multiple systems.



Classic Series



Exclusive Series

DISPLAY OPTIONS

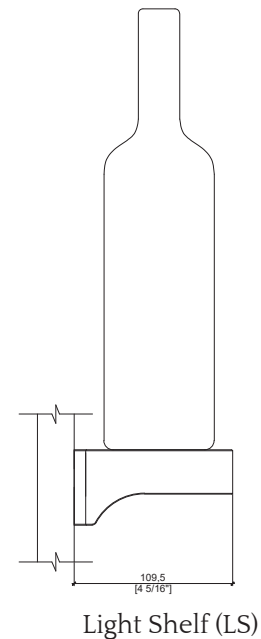
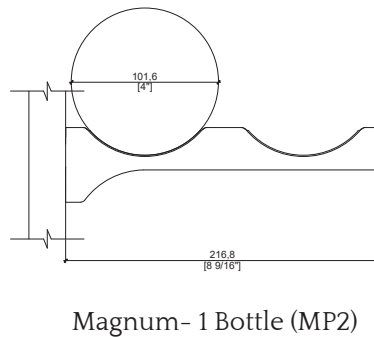
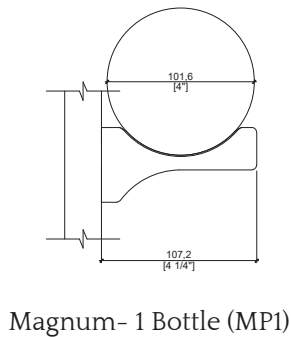
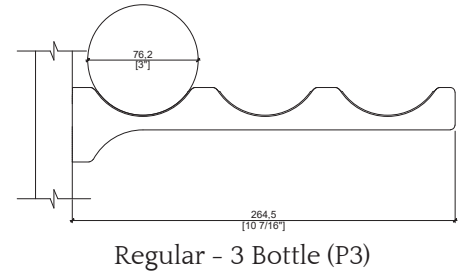
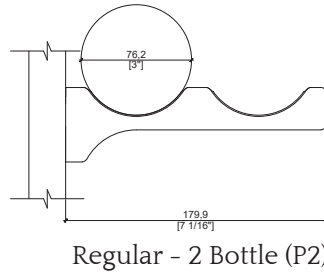
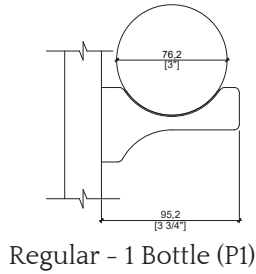

CLASSIC SERIES - Specification Guide

CLASSIC SERIES CONFIGURATION OPTIONS

*options for multiple configurations may be specified in the same system

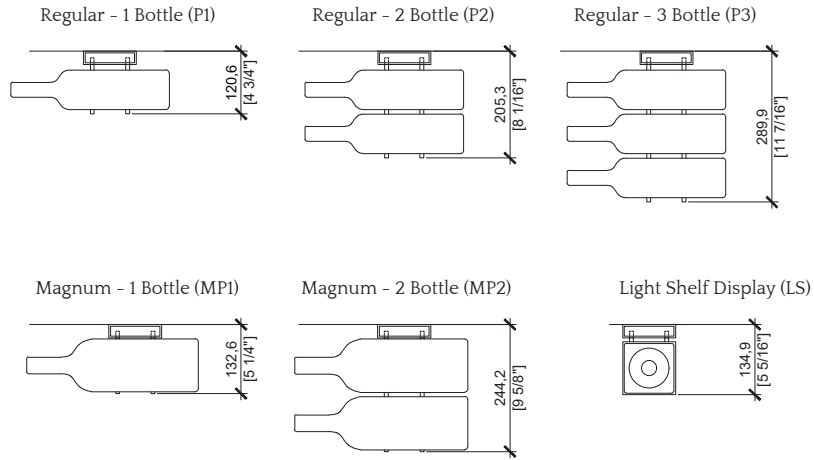

CLASSIC SERIES SPACING REQUIREMENTS

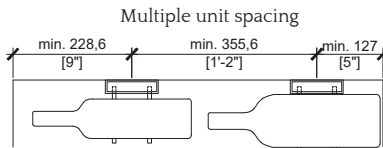

CLASSIC SERIES POST AND FIN DETAIL

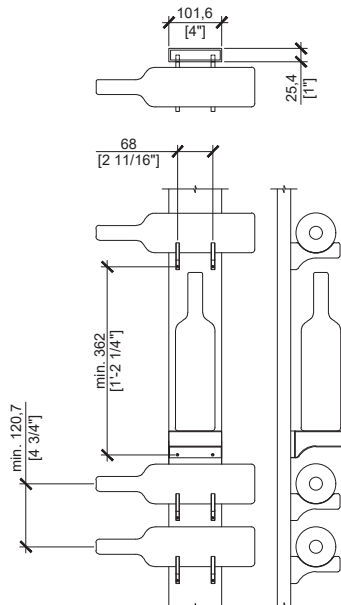

EXCLUSIVE SERIES - Specification Guide

EXCLUSIVE SERIES CONFIGURATION EXAMPLES

*multiple display types may be specified in the same system

Regular - 1 Bottle (P1) - 1 SIDE

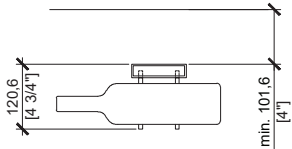

Regular - 2 Bottle (P2) - 1 SIDE

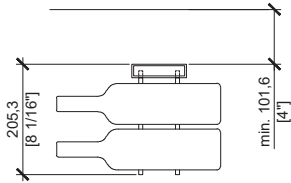

Regular - 3 Bottle (P3) - 1 SIDE

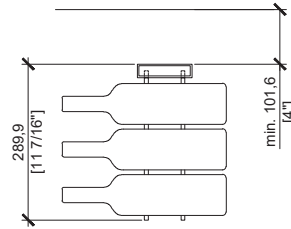

Regular - 1 Bottle (P1) - 2 SIDES

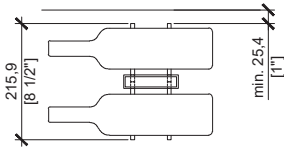

Regular - 2 Bottle (P2) - 2 SIDES

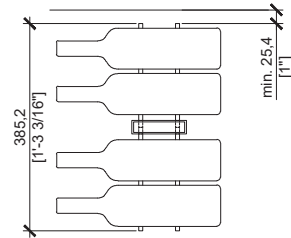

Regular - 3 Bottle (P3) - 2 SIDES

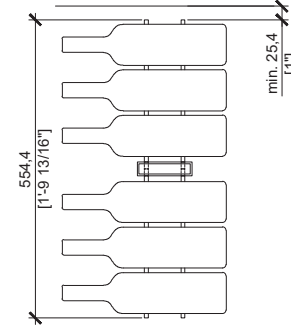

Magnum - 1 Bottle (MP1) - 1 SIDE

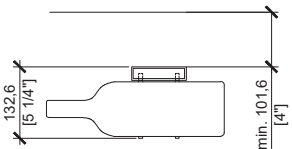

Magnum - 2 Bottle (MP2) - 1 SIDE

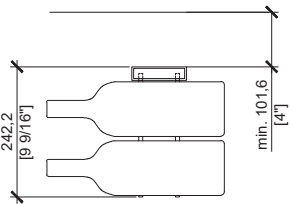

Light Shelf Display (LS) - 1 SIDE

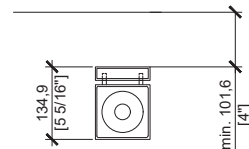

Magnum - 1 Bottle (MP1) - 2 SIDES

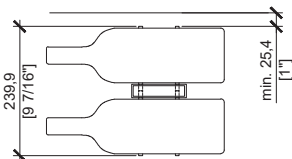

Magnum - 2 Bottle (MP2) - 2 SIDES

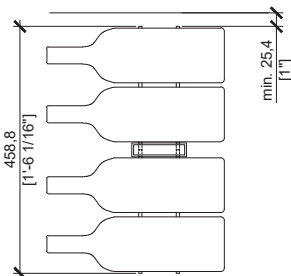

Light Shelf Display (LS) - 2 SIDES

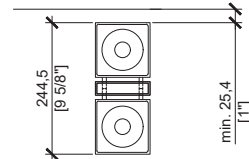

EXCLUSIVE SERIES - Specification Guide

EXCLUSIVE SERIES SPACING REQUIREMENTS

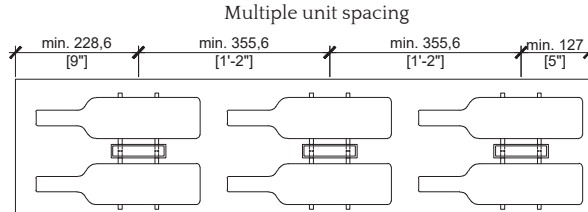

EXCLUSIVE SERIES POST AND FIN DETAILS

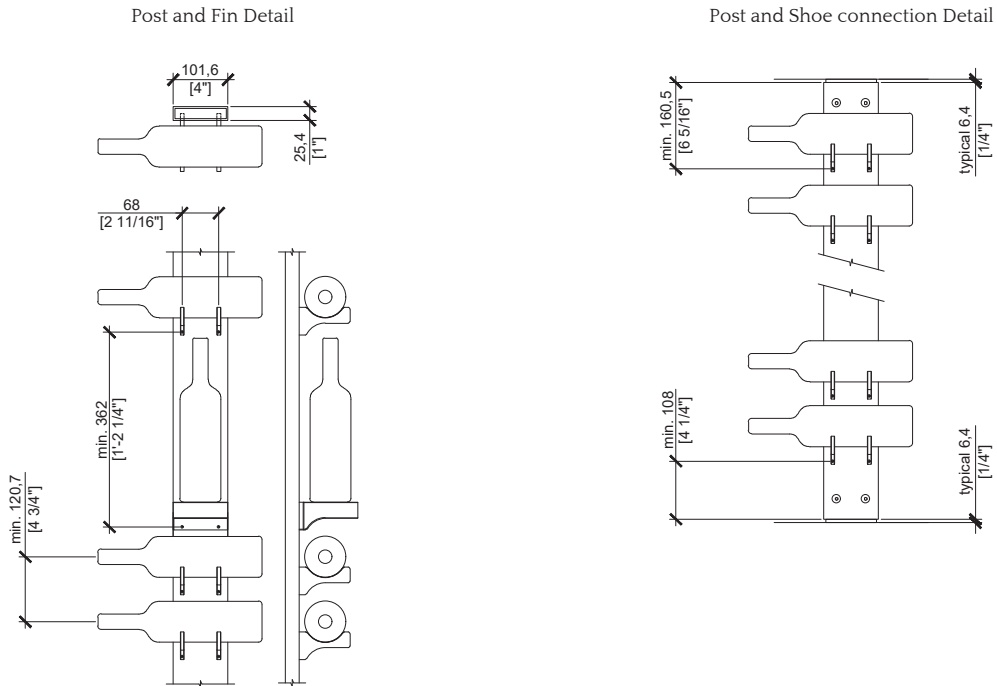

CLASSIC and EXCLUSIVE SERIES - Row Calculation

Height of System	Number of Rows
120" (3048mm)	23
114" (2895.6mm)	22
108" (2743.2mm)	20
102" (2590.8mm)	19
96" (2438.4mm)	18
90" (2286mm)	17
84" (2133.6mm)	15
78" (1981.2mm)	14
72" (1828.8mm)	13
66" (1676.4mm)	11
60" (1524mm)	10
54" (1371.6mm)	9
48" (1219.2mm)	8
42" (1066.8mm)	6
36" (914.4mm)	5
30" (762mm)	4
24" (609.6mm)	3
18" (457.2mm)	2
12" (304.8mm)	1

Imperial Formula (inch)

$$\frac{(\text{Height} - 9.449)}{4.75} = \text{Rows}$$

Metric Formula (mm)

$$\frac{(\text{Height} - 240)}{120.65} = \text{Rows}$$

Example using Imperial Formula for 9'-8" ceiling height:

$$\frac{116" - 9.449}{4.75} = 22.4^*$$

*Round down to full number, therefore 22 rows are allowable for 9'-8" ceiling height with regular spacing.