

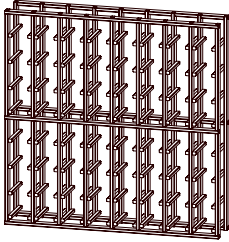

CALIFORNIA REDWOOD WINERACK

INDIVIDUAL MODULES



INDIVIDUAL 8 COLUMN F01 (A)
32" x 32"

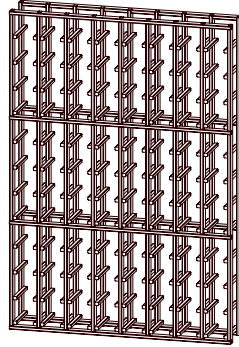

INDIVIDUAL 8 COLUMN F01 (B)
32" x 48"

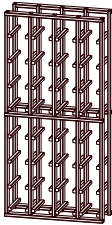

INDIVIDUAL 4 COLUMN F02 (A)
16" x 32"

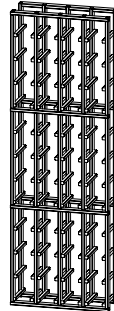

INDIVIDUAL 4 COLUMN F02 (B)
16" x 48"

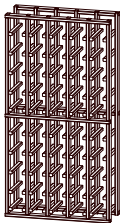

INDIVIDUAL 5 COLUMN F03 (A)
(1/2 bottles)
16" x 32"

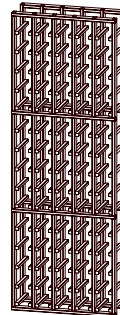

INDIVIDUAL 5 COLUMN F03 (B)
(1/2 bottles)
16" x 48"

TOOLS

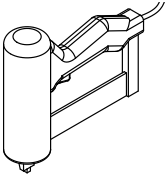

1" - 1/8" Finishing Nailer

Highly recommended to prevent splitting of wood. This tool is also handy for projects around the home.

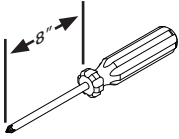

Philips Screwdriver

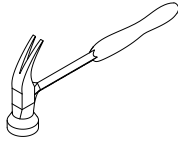

Hammer

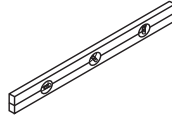

Level

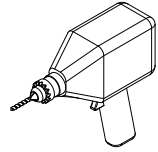

Drill

COMPONENTS

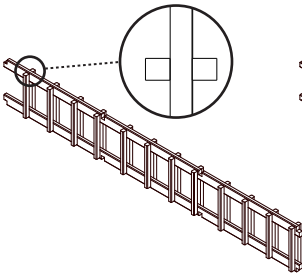

Inner Column

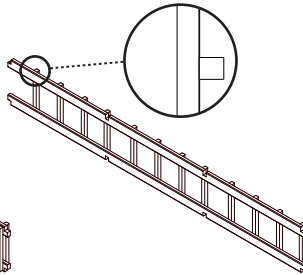

Outer Column

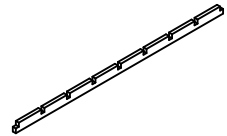

Horizontal Bar

HARDWARE

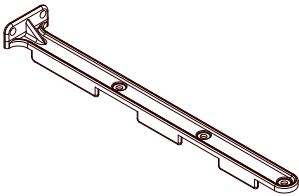

Bracket x 4



1/2" Screw x 8



7/8" Screw x 8



1 1/4" Screw x 8



Anchor x 8



Nails x 56

GETTING STARTED

IMPORTANT NOTE :

Individual WineRack modules are available in a variety of sizes. The Individual 8 column, type B (F01B) is illustrated in the following instructions. Other models have fewer columns or bars, but method of construction is the same.

STEP 1

LAYOUT HORIZONTAL BARS :

Redwood has a variety of natural colours, ranging from red to white. If consistent colour is important to you, sort the bars before assembly. Arrange half the horizontal bars, notches up.

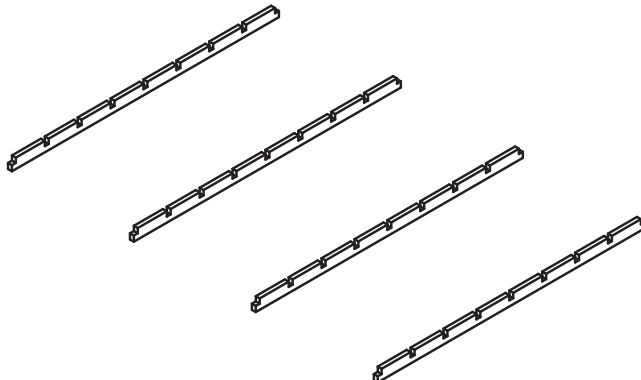

STEP 2

ASSEMBLE BARS AND COLUMNS :

Make sure all column **TOPS** are orientated in the same direction. For identifying the **TOP** and **BOTTOM** refer to circled zoom views.

Place inner and outer columns in the notches of the horizontal bars.

Place remaining horizontal bars down over columns, so that all notches interlock.

OUTER COLUMNS CLEATS ON ONE SIDE

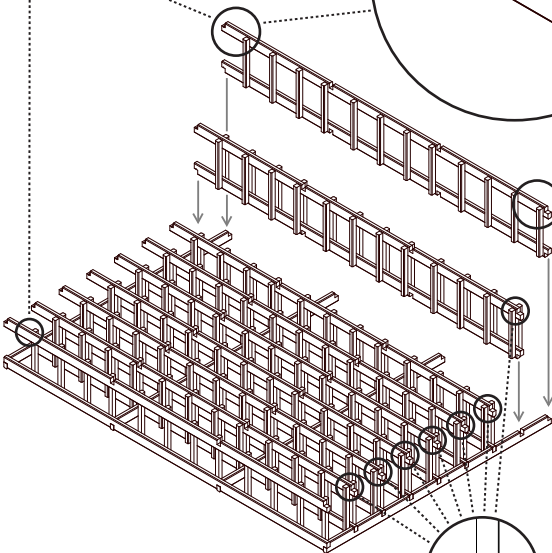
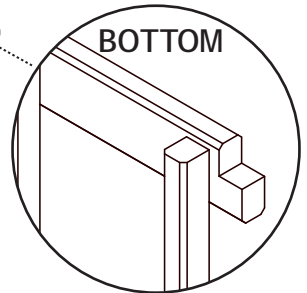
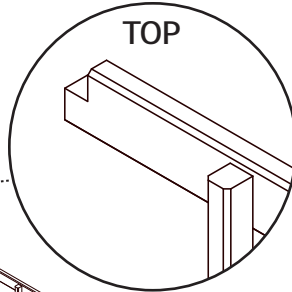
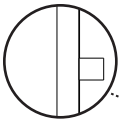

INNER COLUMNS CLEATS ON BOTH SIDES

STEP 3

NAIL HORIZONTAL BARS TO COLUMNS :

Use wall or floor to keep rack steady while nailing. Using a finishing nailer will reduce splitting of wood and speed up assembly.

Nail intersections together as shown (figure A).

Nail through outer columns into ends of horizontal bars (figure B).

Nail at each corner joint (figure C).

Nail through top and bottom horizontal bars into all column ends (figure D).

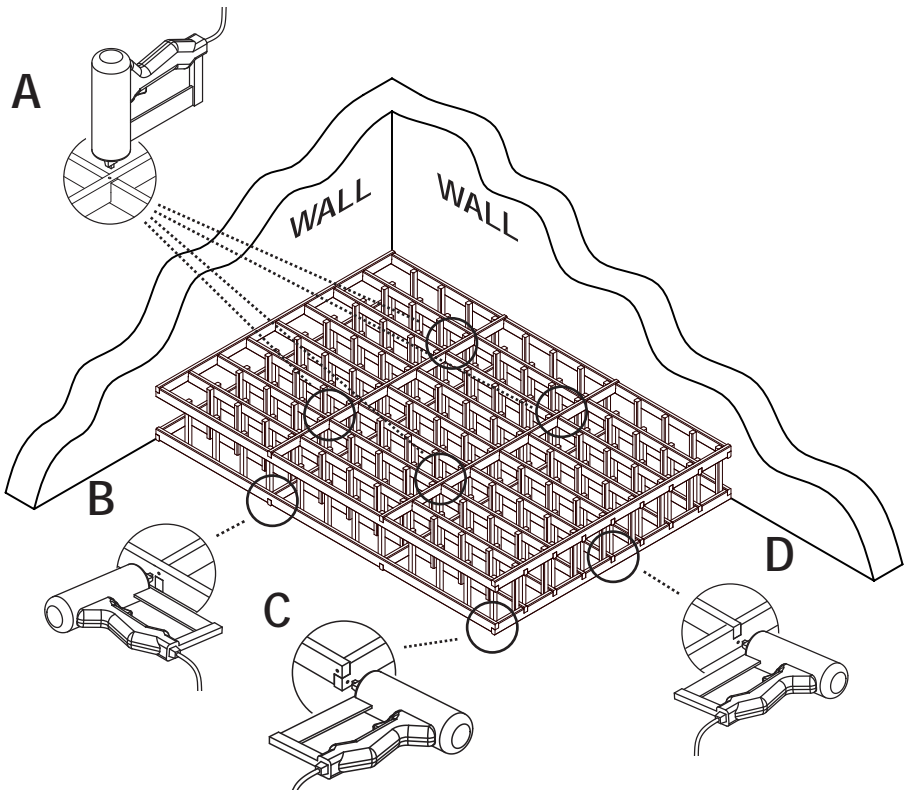

STEP 4

FASTEN BRACKETS TO WINERACK AND WALL :

Place Brackets in position under horizontal bars. Fasten 1/2" screws through holes of brackets (figure A).

BEFORE ATTACHING TO WALL : For a professional look, install a Base Trim Kit* before mounting rack to wall. (Shown on last page)

- Stand winerack in position at wall. Mark through bracket holes with a pencil where plastic anchors should be and drill 1/4" holes at marks (figure B).
- Tap in plastic anchors with a hammer (figure C).
- Move rack back into position and fasten to anchors with 1 1/4" round head screws (figure D).

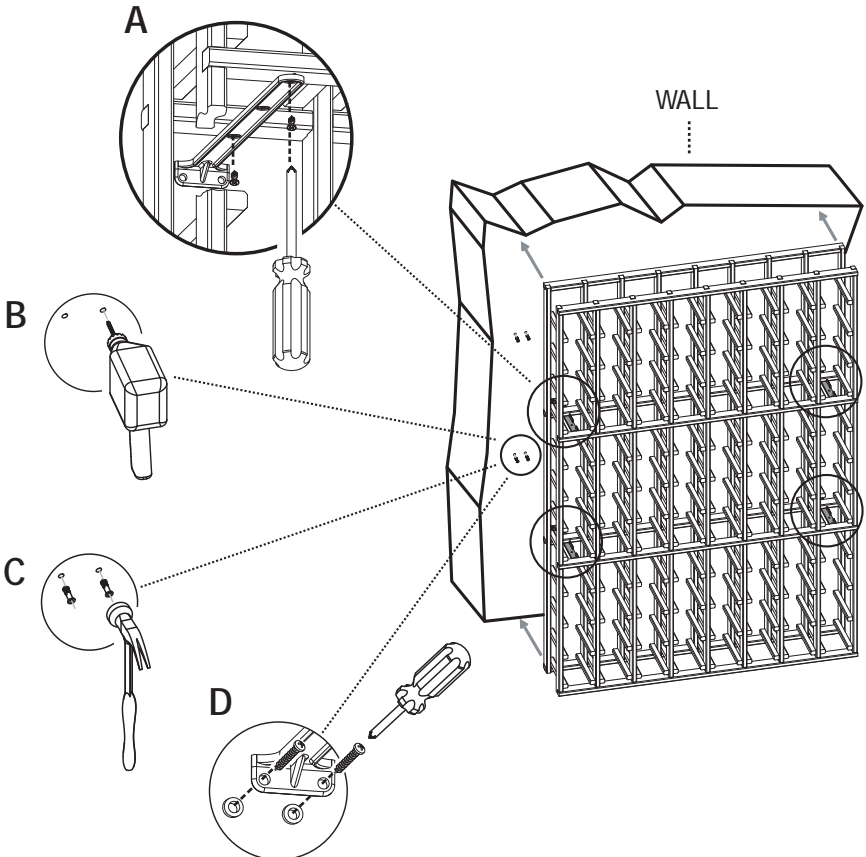

MULTIPLE MODULES

If installing multiple modules, screw adjoining racks together. Fasten through adjoining bars with 7/8" screws at top, middle and bottom rows, as shown. To avoid cracking, pre-drill 1/16" holes for screws. Fasten through rear rack sections as well as front. If stacking modules, fasten adjoining horizontal bars in at least two places. For additional strength and stability, fasten through bottom horizontal bars into base or floor with 7/8" screws or nails.

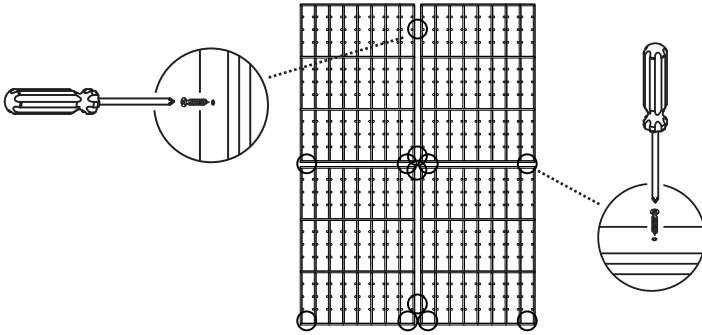

The stackable system is available in 2 heights A (32") and B (48") allowing for the following modularity:

Base / Crown molding and quarter round (optional) can be added to AA and AB configurations for 8' ceiling height.

Base / Crown trim addition to BB requires min. 99" ceiling height.

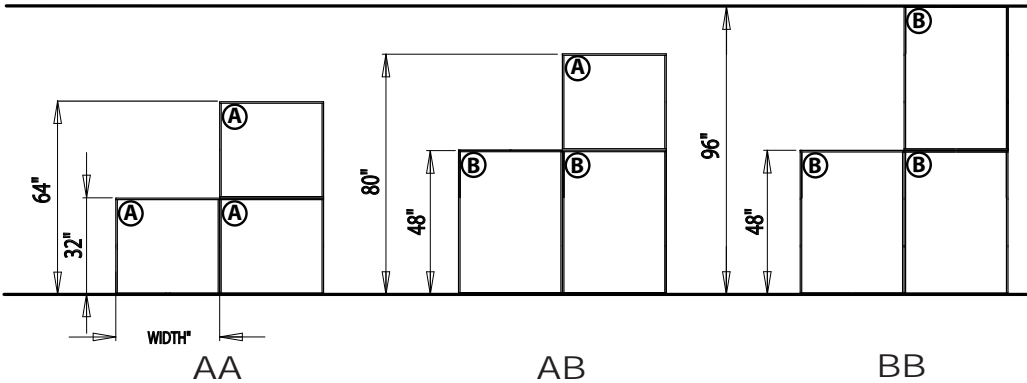

NOTE : All the above configurations assure alignment of modules
 * Nominal 48" B modules are 47 3/4" to allow for stacking in a nominal 8' ceiling room.

TEST BEFORE USE

Use of WINERACK is strictly at your own risk. Drobot Inc. will not accept any responsibility or liability for damages resulting from units not assembled precisely as directed, or not securely fastened to a wall or support with suitable fasteners.

Before placing any bottles in your WINERACK, test it thoroughly to make sure all fasteners are secure.

* BASE AND TRIM KIT

Provides a solid base and professional finish for your WineRack project; The bases come in 3 different lengths 16", 32", 48" and two corner versions (convex and concave). You can order one directly from Vintage Keeper or from your dealer.

With base section in place, check for level and adjust with shims as required. When racks are in place, fasten the lower horizontal bars directly to Base with screws or nails. Nail moldings to face of base and racks.

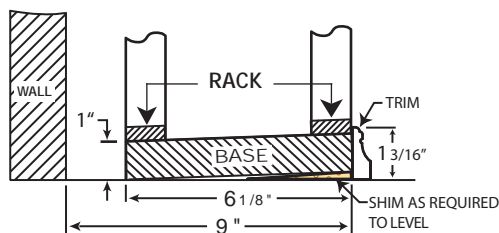

LIMITED WARRANTY

Drobot Inc warrants this product to be free from defects due to workmanship or material, under normal use and service, for a period of one (1) year after the date of purchase. Please call our customer service department at 1-888-274-8813 or e-mail us at info@vintagekeeper.com

This warranty does not cover normal cosmetic wear, cosmetic defects, damage resulting from improper assembly or maintenance, shipping damage, accident, or any misuse, abuse or use contrary to the written instructions. This product is not warranted for commercial use.

The warranties expressed above constitute the entire warranty of Drobot Inc with regard to its products and are in lieu of and exclusive of all other warranties, express or implied, including any of merchantability or fitness for a particular purpose. In no event shall Drobot Inc be liable or responsible for incidental or consequential damages, including spoilage or breakage of wine. It is your own responsibility to insure your wine, and to take all reasonable and necessary precautions to safeguard its condition.