



Ductless Split Wine Cellar Cooling Systems

Installation, Operation and Maintenance Guide



Models:
SS018 – 60 Hz
WGS25 – 50 Hz

Manufactured by:

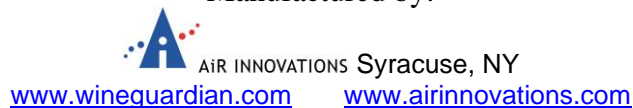

Wine Guardian reserves the right, without notice, to make changes to this document at its sole discretion.
Please visit our web site for the most current version of the Wine Guardian manual and other literature.

Wine Guardian is a registered trademark (2,972,262) of Air Innovations, Inc.

Condensing Unit Patent No. U.S. D791295, EU 003189349-0001

Edition 11-2019

Table of Contents

Illustrations	5
Directory of Terms	2
Receiving, Inspecting and Unpacking the Wine Guardian Unit	3
Review the Packing Slip to Verify	3
General Description	4
The Wine Guardian Ductless Split System Contains.....	4
Wine Guardian Fan Coil Unit	5
Electrical Controls	5
Condensing Unit.....	5
Accessories and Optional Equipment.....	6
Heating Coils	6
Extended Compressor Warranty	6
Low Ambient Option.....	6
Condensate Pump.....	6
Humidifier	6
Remote Temperature/Humidity Controller (see how to install on page 34)	6
Remote Temperature/Humidity Sensor.....	6
Heater Option	7
Serving Temperature Option	7
Wine Guardian Specification Sheet.....	9
Safety	15
Safety Message Conventions	15
Danger.....	15
Warning.....	15
Caution.....	15
Lockout/Tagout Procedure.....	16
Safety Considerations.....	16
Safety Hazards	16
Electrical Hazards.....	16
Electrical Shock Hazards	16
Hot Parts Hazards	16

Moving Parts Hazards	16
Equipment Safety Interlocks	17
Main Power Switch.....	17
Installation	19
Pre-installation Test.....	19
Air Flow Diagram	19
Installing the Fan Coil Unit	21
Planning the fan coil installation	21
Mounting the System	23
Installing the Condensate Drain Connection	25
Installing the Drain Line.....	25
Priming the Drain.....	25
Wiring the Fan Coil Unit for Power	26
Installing the Condensing Unit.....	27
Installation of Interconnecting Refrigerant Lines (Suction and Liquid).....	27
Split System Interconnecting Line Sizing Chart.....	28
Sample Piping Configurations.....	29
Leak Checking and Evacuation Process	30
Wiring.....	30
Refrigerant Charging – for low ambient models only.....	31
Determining the amount of charge	31
Procedures for Charging System with Low Ambient Option (Head Pressure Control)	31
Superheat.....	33
Sub-Cooling	33
Split System Operations Chart	34
Standard Controller Functions.....	36
Installing the Optional Remote Interface Controller and Communication Cable	44
Controller Specification	45
Mounting the Optional Remote Interface Controller (Wired)	46
Mounting the Optional Remote Interface Controller (Wireless)	47
Installation of the Optional Wine Guardian Remote Sensor	48
Mounting the Wired Remote Sensor (Wired)	48
Mounting the Remote Sensor (Wireless)	50
Remote Sensor Pairing Instructions – Multiple Sensors (Wireless)	51
Starting-up and Operating the Wine Guardian	35
Control Settings	35
Controller Functions.....	35

Inspection and Start Up Checklists	52
Receiving and Inspecting	52
Handling and Installing	52
Starting-up the Unit.....	52
Starting-up and Operating the Wine Guardian Split System	53
Turn on the Unit	53
Testing the Fan	53
Running the Unit	53
Setting the Local User Interface Controller	54
Regulating the Wine Cellar Temperature.....	54
Maintenance	55
General.....	55
Cleaning the Condensate Drain System	56
Cleaning the Humidifier.....	56
Heating Coil Option	56
Maintenance Schedule	57
Monthly	57
Yearly	57
Troubleshooting	58
Typical start up problems	58
Unit does not start up	58
Power switch light is on and the remote interface controller light is off.....	58
Power switch light is on and the remote interface controller light is on	58
Unit is operating and blows evaporator air,.....	59
Cellar temperature too cold (below 51 degrees) when unit is running	59
Cellar temperature too cold (below 51 degrees) when unit is not running.....	59
Humidity too low or supply air is too cold, without optional humidifier	59
Humidity too low, without optional humidifier.....	60
Humidity too low, with optional humidifier	60
Humidity too high when unit is running but not cooling.....	60
Humidity too high when unit is not running.....	60
Humidity too high when unit is running and cooling.....	60
Unit operates but the power switch light is not ON	61
Unit is leaking water	61
Unit is running properly, but the sound of the unit objectionable	61
High Pressure Switch has Shut the Unit Down	61
Advanced Troubleshooting	62

Evaporator Coil is Freezing	62
High pressure switch keeps tripping.....	62
Unit cycles on and off more than 8 times/hr.....	62
High pitched or loud rubbing noise, clanking or vibration	63
Replacing the blowers.....	63
Contact and Warranty Information	63
Contact Information	63
Warranty and Warranty Procedure	63
Manufacturer’s Warranty – U.S. and Canada Only	64

Illustrations

Overview of fan coil and condensing unit	8
Wine Guardian specification sheet	9
Refrigeration Illustration.....	10
Ductless Dimensional drawings for models SS018 & WGS25	11
Wiring diagram for model SS018.....	12
Wiring diagram for model WGS025.....	13
Wiring diagram for models SS018 & WGS25 condensing unit.....	14

Directory of Terms

Ambient Air – The surrounding area outside the wine cellar such as a room, basement, garage or outdoors.

BTU/H – British thermal units/hour. A unit of measurement to describe the power of heating and cooling system.

CFM – Cubic feet per minute. A unit of measurement for the amount of air handled by the fan.

Condensate / Condensation – The water formed out of the air when it is cooled below a certain temperature (called dew point). Often referred to as “sweating” on pipes and cold surfaces. This water collects at the bottom of the evaporator or cooling coil and drains out of the unit through the drain line.

Condensing Unit (Heat Rejection) – The condensing unit uses the compressor, condenser coil and fan to remove heat from the refrigerant to the ambient air *outside* the wine cellar. The word condenser refers to the condensation of the refrigerant from gas to liquid phase.

CSA/ETL – Canadian Standards Association/Edison Testing Laboratory (product compliance to safety standards)

F – (Degrees) Fahrenheit

Fan Coil Unit (Evaporator Cooling) – The fan coil unit uses the cooling coil and the fan to remove heat from the air *inside* the wine cellar to the refrigerant, cooling the air and condensing moisture out of the air. The word evaporator refers to the evaporation of the refrigerant from liquid to gas phase in the coil. The fan coil unit is ducted to or can be placed inside the wine cellar.

Grille or Diffuser – Inlet or outlet plates to direct the airflow or protect the inside of the unit.

Heat Gain / Loss – The amount of cooling or heating expressed in BTUH and watts transferred between the wine cellar and the ambient space. The Wine Guardian must offset this heat/gain loss.

Inlet Air – The air returning from the wine room to the Wine Guardian fan coil.

I.D. – Inside diameter

NEC – National Electrical Code

O.D. – Outside diameter

Psig– Pounds force per square inch gauge pressure

Recovery – The amount of cooling the unit does to return the cellar to its set point temperature after some new heat load is introduced, such as people or new cases of warm wine entering the cellar.

Return Air - The air leaving the cellar and returning to the inlet of the fan coil. (See Inlet Air above)

TXV – Thermal expansion valve

VAC – Volts alternating current

SP – Static pressure. Unit of measurement (inches of water column) of the pressure of the air handled by the fan.

Set Point – The desired temperature or humidity set on the remote interface controller or humidistat.

Supply Air - The air entering the wine cellar from the discharge of the fan coil.

Receiving, Inspecting and Unpacking the Wine Guardian Unit

NOTE: Wine Guardian units are factory assembled and tested prior to shipment. The Wine Guardian Ductless Split System consists of two separate components, the Wine Guardian fan coil and condensing unit.

Each Wine Guardian component is shipped in a corrugated box. A shipment may include one or more boxes containing accessories.

- ✓ Lift at the designated handhold locations only or fully support from underneath.
- ✓ Before opening, inspect the packing crates or boxes for obvious signs of damage or mishandling.
- ✓ Write any discrepancy or visual damage on the bill of lading before signing.
- ✓ Inspect all equipment for any sign of damage caused during transit.
- ✓ Report all visual or concealed damage to the carrier and file a claim immediately.
- ✓ Thoroughly inspect the contents for any visible damage or loose parts.

IMPORTANT

If this procedure is not followed, the shipping company may reject the claim and the consignee may suffer the loss. Do not return the shipment to the factory.

Review the Packing Slip to Verify

- ✓ Model number
- ✓ Factory installed options
- ✓ Unit accessories

If any items listed on the packing slip do not match your order information, contact the place of purchase immediately.

General Description

The Wine Guardian cooling unit is a professional grade, American-manufactured, split two-piece climate control unit designed specifically for the storage of wine at cellar temperatures. It is designed for easy installation and operation. Wine Guardian uses digital electronic controls and R-134a refrigerant. The entire Wine Guardian system is tested at the factory. All components are of a high quality standard commercial grade.

The system is approved by ETL according to UL 1995 and CSA safety standards. All wiring complies with NEC. Each Wine Guardian fan coil section is furnished with a sealed, UL-approved power cord and plug.

All Wine Guardian 50Hz units carry the CE mark. Each unit is furnished with a sealed, CE- approved power cord and plug.

The Wine Guardian Ductless Split System Contains

1. **A Wine Guardian Fan Coil Unit with:**

- ✓ A thermal expansion valve to control the flow of refrigerant into the evaporator coil
- ✓ A removable control panel for ease of service

1a. Optional

- ✓ Optional: Remote interface controller and control cable

2. **A Condensing Unit with:**

- ✓ A filter dryer to keep the refrigerant clean and free of contaminants
- ✓ A sight glass to observe the level of refrigerant
- ✓ A manual reset high pressure switch on the discharge to protect the compressor from high pressures.
- ✓ Auto reset low pressure switch
- ✓ 24-volt contactor for control of fan coil unit
- ✓ Oversize receiver
- ✓ Service valves
- ✓ Outdoor enclosure

2a. Included with Low Ambient Option

- ✓ Crankcase heater
- ✓ LAC valve
- ✓ Outdoor enclosure

Wine Guardian Fan Coil Unit

The Wine Guardian fan coil unit meets its rated capacities for total BTU/H and CFM (watts and M³/h for 50Hz) at design cellar conditions and external static pressures. The fan is a motorized impeller type, statically and dynamically balanced, and uses permanently lubricated direct drive motors requiring no maintenance.

The Wine Guardian fan coil section operates as air passes through the sides of the decorative front panel and through the cooling coil where it is cooled by the refrigerant inside the coil. This causes any excess humidity in the air to condense and be captured in the drain pan and piped outside the unit. Air is then pressurized and discharged out of the unit through the top screened section. Optional heating coils are located between the cooling coil and the fan. These coils heat the air to prevent low temperatures within the cellar.

All exterior framing of the Wine Guardian is powder coated 0.063-inch gauge aluminum to prevent rust and corrosion. All coils are aluminum tubes, aluminum fins, to prevent premature corrosion.

Each unit is provided with a pre-wired and tested local user interface controller mounted on the chassis within the Wine guardian unit. The user interface controller has multiple control functions for cooling, heating and humidification. It has a fully automatic mode to switch between heating and cooling.

Electrical Controls

The main electrical control board and components are located on a separate panel, internal to the chassis. All wiring is in accordance with the NEC. Wires are numbered and color coded to match the wiring diagrams.

Electric power is supplied by a single factory-furnished cord and plug. All external controls are digital and proprietary to Wine Guardian products. Only approved communication cable and Wine Guardian controllers are suitable for proper system operation.

Condensing Unit

Compressors are rotary, self-lubricating, permanently sealed, hermetic reciprocating-type compressors, with internal overload protection and capacitor start. They include a minimum of 24 months' manufacturer's warranty and an optional five-year warranty. Compressors are mounted on rubber-in-shear isolators to reduce noise and vibration. Additional features include a liquid line filter drier, Sporlan Head Master Controls, a liquid line receiver and refrigerant sight glass. Each unit is housed in a painted aluminum enclosure suitable for outdoor installation. The outdoor enclosure has adequate area for ventilation and refrigerant piping penetrations.

IMPORTANT

The air exhaust from the condensing unit is hot and will be 25°F to 35°F or 15°C to 20°C above the entering temperature. The condensing units are rated for a maximum temperature of 115°F (46°C). The condensing units should be installed in a well-ventilated area to ensure proper air flow across the condenser coil and to limit short cycling.

Accessories and Optional Equipment

Heating Coils

An optional heating coil is built in and requires no additional power source. The electric heating option is factory installed and includes primary and secondary over-temperature protection devices per UL and NEC.

Extended Compressor Warranty

The Wine Guardian uses only the best commercially available compressors on the market. However, since the compressor is the single most expensive component in the unit, it is recommended that you purchase the extended warranty option.

Low Ambient Option

A factory-installed low ambient option is available that makes the Wine Guardian capable of exposure to low ambient temperatures. This feature maintains system pressures to prevent freezing the cooling coil and heats the compressor oil reservoir. The low ambient option is recommended whenever the condenser section is exposed to air temperatures below 40°F (4°C).

Condensate Pump

An optional Wine Guardian automatic condensate pump is available to pump the water to a remote sink, drain pipe or outside. It requires a separate 120-volt electrical outlet. 50Hz models require a separate 220/240-volt electrical outlet.

Humidifier

Another popular option for the Wine Guardian is the Standalone humidifier. The humidifier is sold and installed as a standalone system. Each humidifier is furnished with a communication cable connection to plug into the Wine Guardian fan coil unit. It is then controlled by the same user interface controller that is used for the operation of the Wine Guardian unit. The humidifier requires a water supply and drain for operation.

Remote Temperature/Humidity Controller (see how to install on page 34)

The remote temperature/humidity controller (Remote Interface Controller) is intended to provide a means for user interface at a remote location. The controller can be used as a remote sensor/controller mounted within the wine cellar remote from the Ductless Split System. The controller can also be used as a remote indicator (without sensor) mounted directly outside of the wine cellar of the residence or building. The Remote Interface Controller includes a backlit face for temperature and humidity indication along with controller set-up and operational functions.

Remote Temperature/Humidity Sensor

The remote temperature/humidity sensor is intended to provide a means of sensing one or more locations within the wine cellar and designed to work in conjunction with the Remote Interface Controller or Local Interface Controller integral to the Wine Guardian Ductless Split System. Multiple sensor readings are averaged and controlled to a single point. The sensors do not have any temperature or humidity indication and must be mounted within the wine cellar.

Heater Option

The electric heat option includes an integral electric heating element, thermal overload protection device and controls. The Wine Guardian will either cool or heat the air, but it is not designed to do both at the same time.

Serving Temperature Option

The serving-temperature option allows a Wine Guardian unit to control to an extended temperature range from 42° F to 64° F (5°C - 18°C). The serving temperature option consists of a cooling coil mounted temperature sensor and control to prevent freeze up of the coil during low temperature operation.



**CAREFULLY FOLLOW THE INSTALLATION INSTRUCTIONS INCLUDED WITH THE HUMIDIFIER.
REFER TO THE INSTRUCTIONS CONTAINED IN THE BOX FOR THE HUMIDISTAT.**

**Overview
split system fan coil**

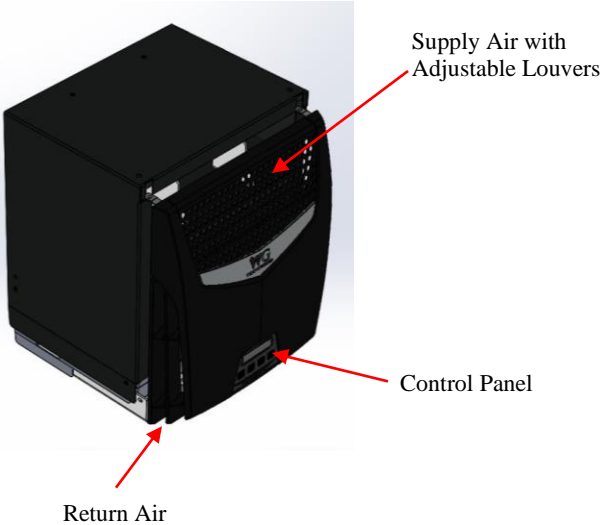

**View from bottom Rear
of Evaporator Indoor Unit**

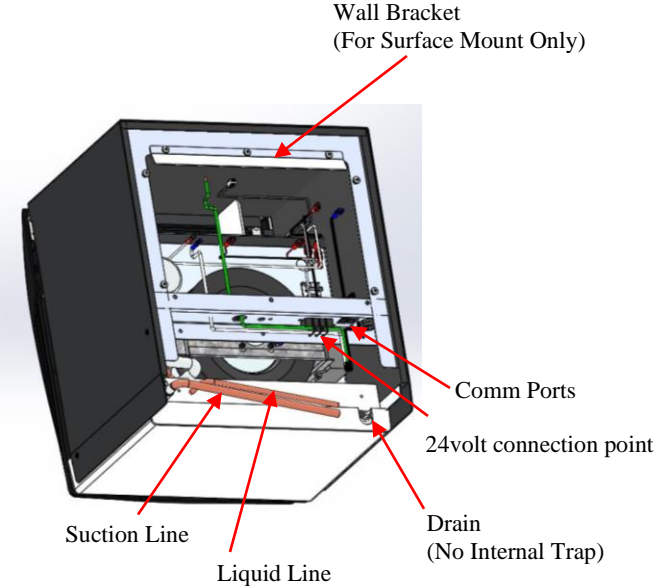

View from Right Rear with Access Panel and Side Panels Removed

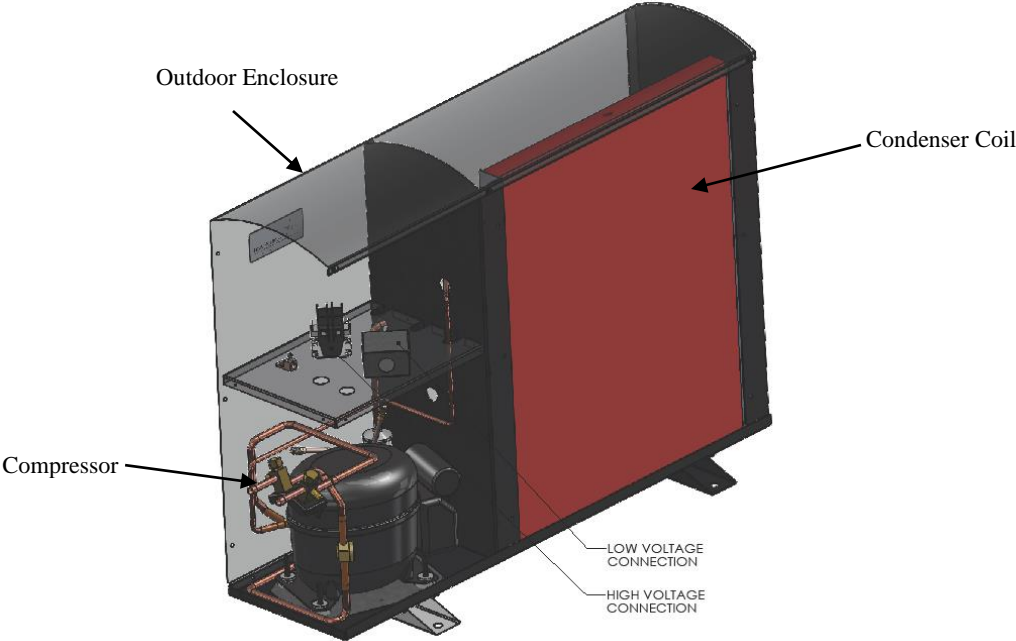

Wine Guardian Specification Sheet



SPECIFICATIONS

Ductless Split System - 60Hz and 50Hz

Model Number	SS018	WGS25
Performance		
Net Cooling * Total Sensible	Total/Sensible @115V	Total/Sensible @220-240V
@10 Deg F (minus 12 Deg C) condenser inlet air	2870/2300 BTUH	810/650 Watts
@40 Deg F (4 Deg C) condenser inlet air	2580/2050 BTUH	730/570 Watts
@60 Deg F (15 Deg C) condenser inlet air	2860/2230 BTUH	780/625 Watts
@70 Deg F (21 Deg C) condenser inlet air	2870/2260 BTUH	785/620 Watts
@80 Deg F (27 Deg C) condenser inlet air	2800/2220 BTUH	760/61 Watts
@100 Deg F (32 Deg C) condenser inlet air	2600/2100 BTUH	680/520 Watts
@115 Deg F (46 Deg C) condenser inlet air	2300/1800 BTUH	610/470 Watts
@122 Deg F (50 Deg C) condenser inlet air	2000/2000 BTUH	500/500 Watts
Controls		
Type	Room mounted non-programmable combination thermostat humidistat	
Temperature Accuracy/RH% Accuracy	+/- 1 Deg F / +/- 10% RH	
Fan-coil Section	Rated Watts	Rated Watts
Fan Motor Size	75 Rated Watts	85 Rated Watts
Rated Air Flow (free blow)	150 CFM	240 M ³ /h
Heat (Option)		
Type	Electric	Electric
Capacity	1000 Watts	1000 Watts
Humidifier (Option)		
Type	Removeable drip pad with integral fan	
Capacity - water temp of 60 Deg F (15 Deg C)	0.42 lbs/hr	1.19 kg/hr
Capacity - water temp of 90 Deg F (32 Deg C)	0.97 lbs/hr	1.44 kg/hr
Capacity - water temp of 120 Deg F (49 Deg C)	1.11 lbs/hr	1.5 kg/hr
Electrical Requirements		
Power	115 Volt /1 phase /60Hz	220-240Volts /1 phase / 50Hz
Current Draw - Cooling mode	0.7 Amps	0.4 Amps
Current Draw - Heating mode	5.05 Amps	2.3 Amps
Minimum Circuit Size (w/heat option)	6.2 Amps	3.3 Amps
Optional Humidifier	0.3 Amps	0.3 Amps
Cabinet		
Fan coil construction	Aluminum	
Finish	Black - textured epoxy powder coat	
Weight	25 lbs	11.3 kg
Length	13.31 inches	33.80 cm
Width	14.25 inches	36.20 cm
Height	15.87 inches	40.30 cm
Condensate Drain		
	0.5 inches	12.7 mm
Condensing Unit	SS018 Cond	WGS25 Cond
Nominal Compressor	1/4 HP	1/2 HP
Fan Motor Size	75 Watts	68 Watts
Rated Air Flow (free blow)	350 CFM	510 M ³ /h
Weight	75 lbs	34 kg
Enclosure		
Construction	Aluminum	Aluminum
Finish	Powder-coated	Powder-coated
Length	34.0 inches	86.36 cm
Width	12.3 inches	31.24 cm
Height	26.07 inches	66.22 cm
Electrical Requirements		
Power	208-230 Volts /1 Phase /60Hz	220-240 Volts /1 Phase /50Hz
MCA	3.3 Amps	3.43 Amps
MOP	6 Amps	7 Amps
Agency Approval(s)		
	ETLc	CE
1. Net cooling capacity at entering temperature and humidity conditions of 57 Deg F (14 Deg C) and 55% RH at rated airflow. Reduce capacity by 3% for each 10% reduction in evaporator airflow. 2. Wine Guardian reserves the right to make changes to this document without prior notice at its sole discretion. 3. All ratings at sea level.		

REV. 11-2019

7000 Performance Drive | North Syracuse, New York 13212 USA
 800-825-3268 | 315-452-7420 | Fax 315-452-7420 | www.wineguardian.com | info@wineguardian.com

Refrigeration Illustration of the System

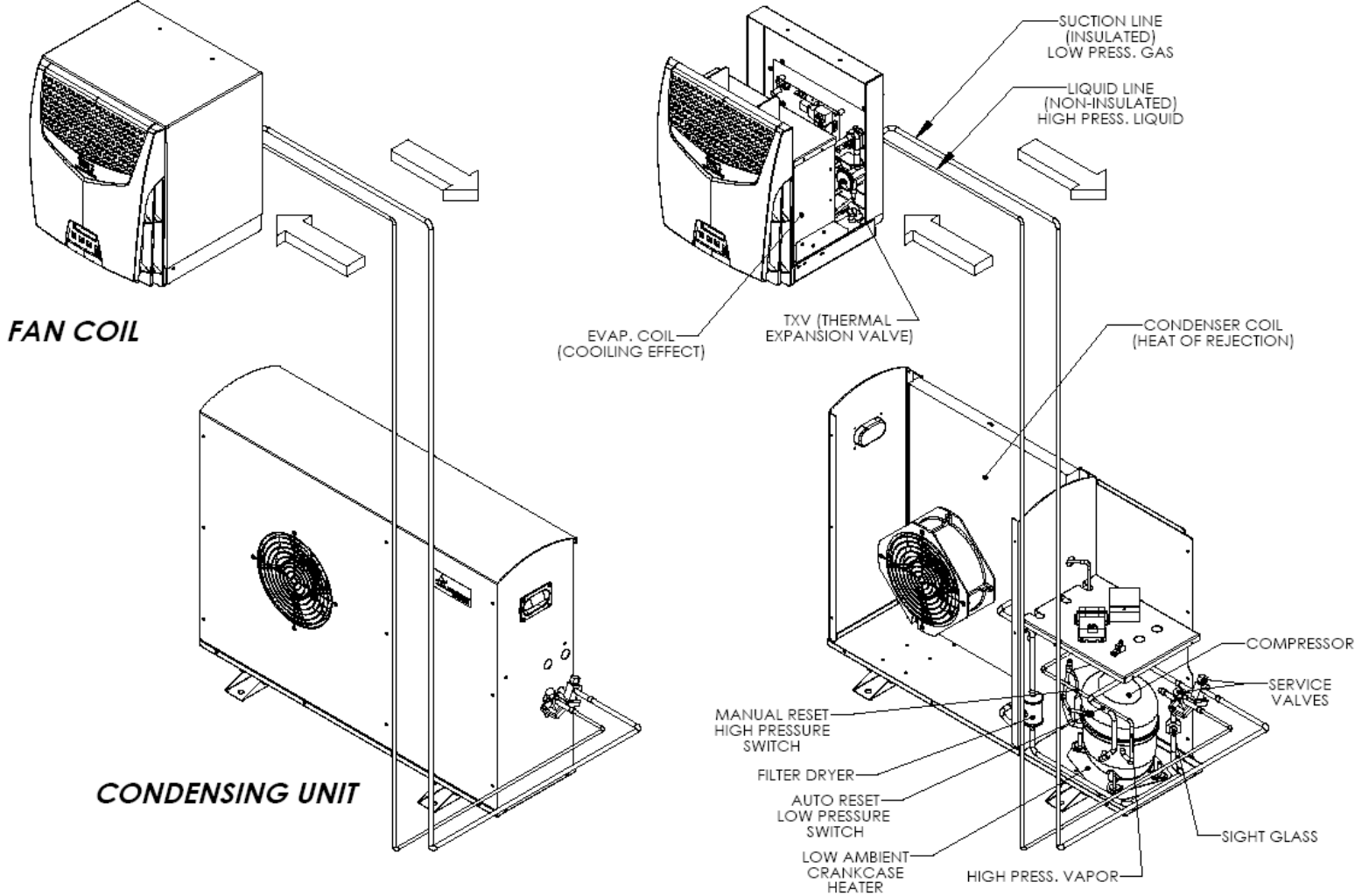

Ductless dimensional drawing for models SS018 and WGS25

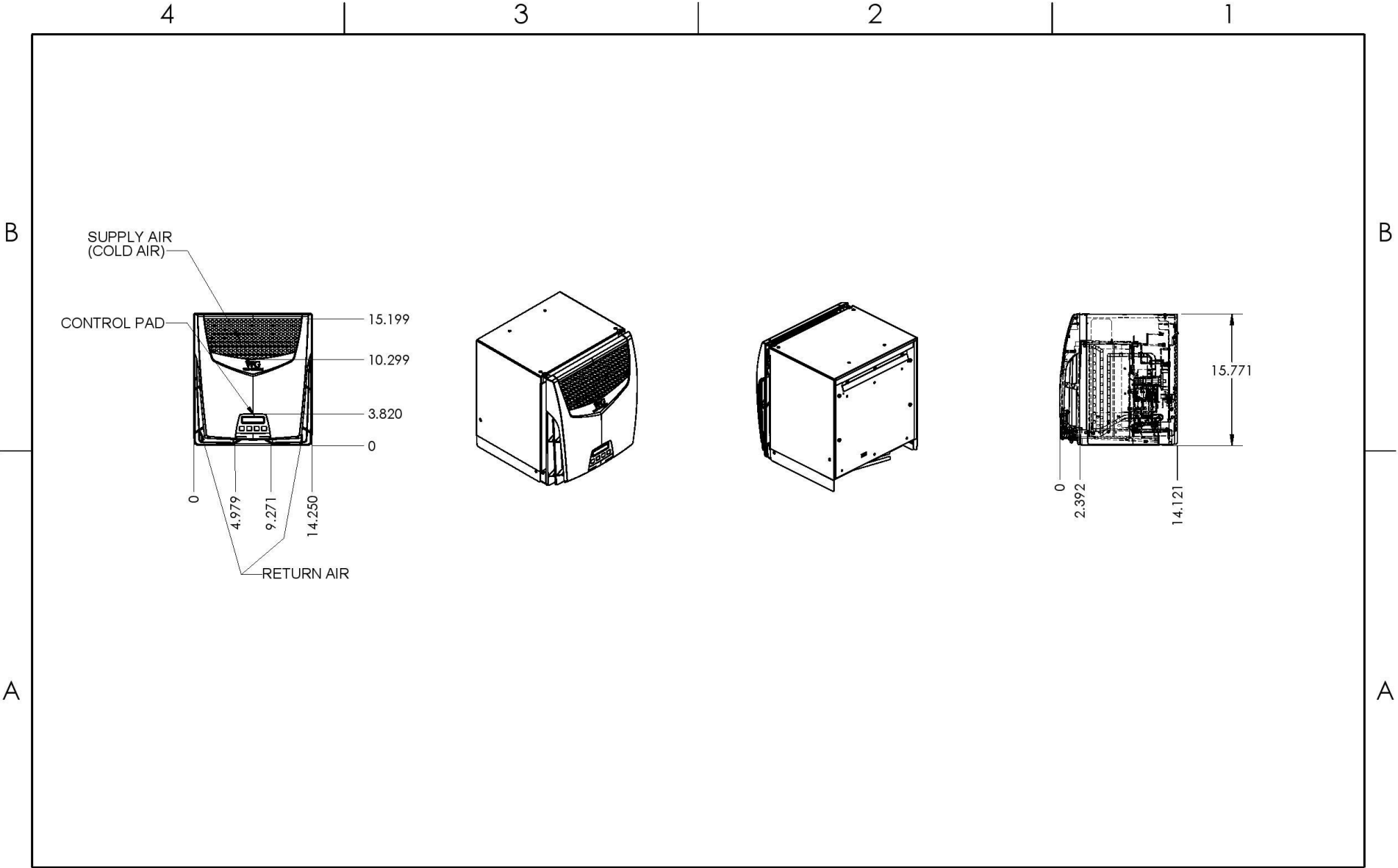

Condensing unit dimensions

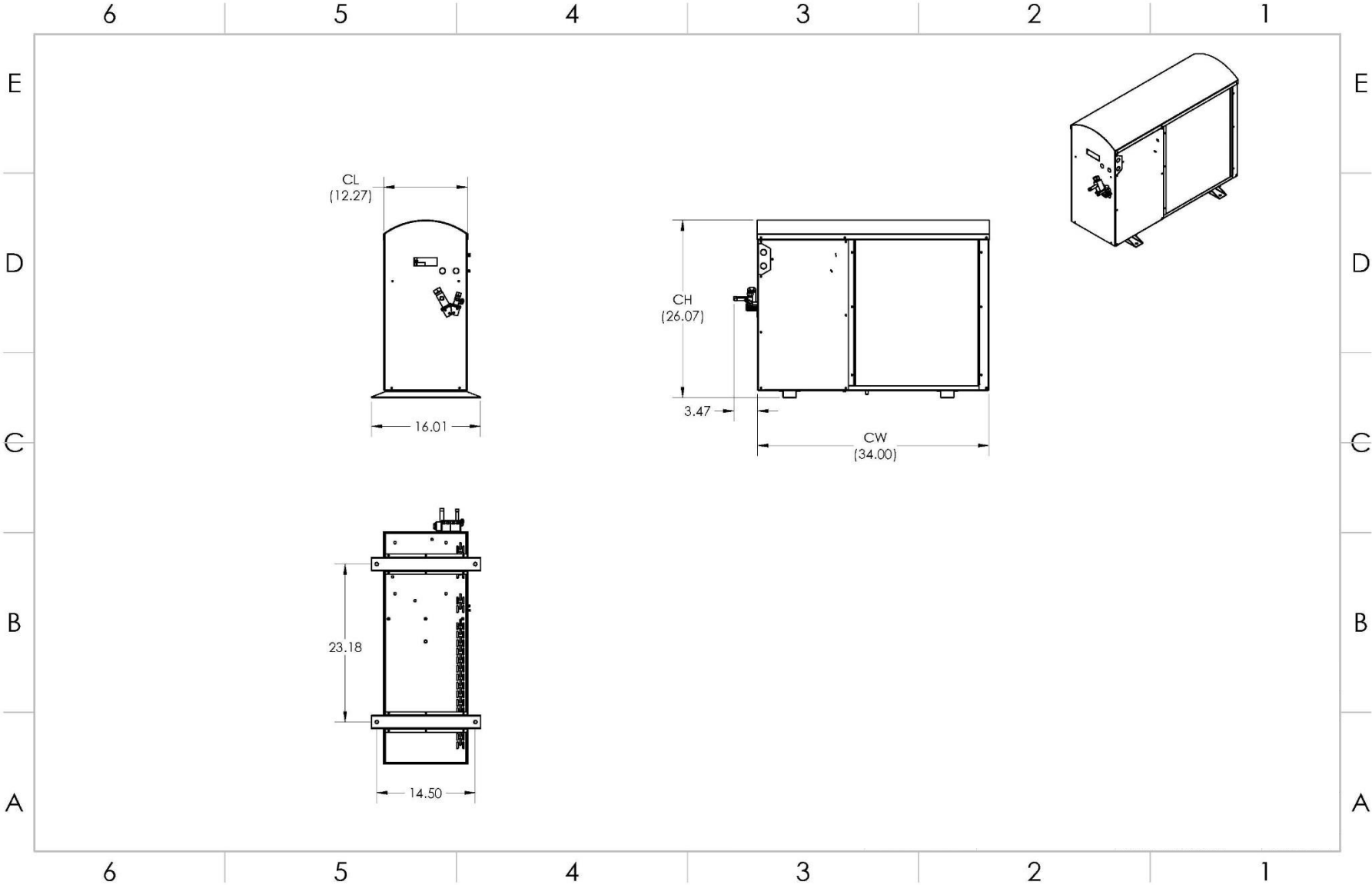

Safety

IMPORTANT

The equipment described in this manual uses electricity. When using this equipment, be sure to follow the safety procedures outlined in this manual.

Safety Message Conventions

Safety messages contained in this manual, **DANGER**, **WARNING**, and **CAUTION** are bold and highlighted in red for quick identification.

Danger

A Danger message indicates an imminently hazardous situation which, if not avoided, results in death or serious injury. Messages identified by the word **DANGER** are used sparingly and only for those situations presenting the most serious hazards.

Following is a typical example of a Danger message as it could appear in the manual:

 **DANGER** 
HIGH VOLTAGE - RISK OF SERIOUS INJURY OR DEATH
High voltages are present in the cabinets.
Before opening panels turn off all power.
Use the Lockout/Tagout procedure.

Warning

A Warning message indicates a potentially hazardous situation which, if not avoided, could result in death or serious injury.

Following is a typical example of a Warning message as it could appear in the manual:

 **WARNING** 
RISK OF PERSONAL INJURY OR DAMAGE TO EQUIPMENT
Modification to the equipment may cause injury.

Caution

A Caution message indicates a potentially hazardous situation which, if not avoided, could result in minor or moderate injury. It may also be used to alert against unsafe practice.

Following is a typical example of a Caution message as it could appear in the manual:

 **CAUTION** 
RISK OF PERSONAL INJURY OR DAMAGE TO EQUIPMENT
Improper installation may result in the equipment malfunctioning and a safety hazard.
Read all of the installation instructions before installing the Wine Guardian unit.

Lockout/Tagout Procedure

- 1) Turn off the power switch (indicator light should be off)
- 2) Unplug the unit from the electrical outlet and cover the outlet to prevent accidentally plugging in the unit.
- 3) Turn off circuit breaker or disconnect switch at condensing unit.

Safety Considerations

The equipment covered by this manual is designed for safe and reliable operation when installed and operated within its designed specifications. To avoid personal injury or damage to equipment or property when installing or operating this equipment, it is essential that qualified, experienced personnel perform these functions using good judgment and safe practices. See the following cautionary statements.

IMPORTANT
Installation and maintenance of this equipment is to be performed only by qualified personnel who are familiar with local codes and regulations, and are experienced with this type of equipment.

Safety Hazards

Exposure to safety hazards is limited to maintenance personnel working in and around the unit. When performing maintenance, always use the Lockout/Tagout procedure, which is described in this chapter. Observe the maintenance safety guidelines in this manual.

Electrical Hazards

Working on the equipment may involve exposure to dangerously high voltage. Make sure you are aware of the level of electrical hazard when working on the system. Observe all electrical warning labels on the unit.

Electrical Shock Hazards

All power must be disconnected prior to installation and servicing this equipment. More than one source of power may be present. Disconnect all power sources to avoid electrocution or shock injuries.

Hot Parts Hazards

Electric resistance heating elements must be disconnected prior to servicing. Electric heaters may start automatically. Disconnect all power and control circuits prior to servicing the unit to avoid burns.

Moving Parts Hazards

The Motor and Blower must be disconnected prior to opening access panels. The motor can start automatically. Disconnect all power and control circuits prior to servicing to avoid serious injuries or possible dismemberment.

The fans are free-wheeling after the power is disconnected. Allow the fans to stop completely before servicing the unit to avoid cuts or dismemberment.

Rotating Fan Blades are present in the Wine Guardian unit. Sticking a hand into an exposed fan while under power could result in serious injury. Be sure to use the Lockout/Tagout procedure when working in this area or remove the power cord.

Equipment Safety Interlocks

There are no electrical safety lockouts installed within the unit. The power cord attached to the control box must be disconnected from the power sources prior to working on any part of the electrical system.

Main Power Switch

The main power switch is located on the front user interface of the Wine Guardian unit. It shuts off the power to the fan coil unit. A separate disconnect switch will be wired to the condensing unit. Both switches must be turned off prior to servicing equipment.

Energy Type	Electrical
Hazard	Electrocution, electrical burns and shock
Magnitude	120 Volts and 230 volts / 1phase / 60Hz (SS018 model) 220-240 volts / 1 phase / 50Hz (WGS25 model)
Control Method.....	Disconnect power cord and On/Off switch



- **Never** reach into a unit while the fan is running.
- **Never** open an access door to a fan while the fan is running.
- **Disconnect** the power cord switch before working on the unit. The unit may have more than one power source to disconnect.
- **Avoid** risk of fire or electric shock. **Do not** expose the unit to **rain** or **moisture**.



- **Check** weights to be sure that the rigging equipment can support and move the Wine Guardian unit safely. Note any specific rigging and installation instructions located in the Installation section of this manual.
- All supports for the unit **must** be capable of safely supporting the equipment’s weight and any additional live or dead loads encountered.
- All supports for the unit **must** be designed to meet applicable local codes and ordinances.
- **Do not** remove access panels until fan impellers have completely stopped. Pressure developed by moving impellers can cause excessive force against the access panels.
- Fan impellers continue to turn (free-wheel) after the power is shut off.



- **Clean** only with a dry cloth.
- **Never** pressurize equipment above specified test pressure. See Wine Guardian Specification sheet on page 10.
- **Do not use the Wine Guardian near water.**
- **Do not** block any supply or return air openings. Install in accordance with the instructions in this manual. Do not defeat the safety purpose of the polarized or grounding type plug. A polarized plug has two blades with one wider than the other. A grounding type plug has two blades and a third grounding prong. The wide blade or the third prong is provided for your safety. If the provided plug does not fit into your outlet, consult an electrician for replacement of the obsolete outlet.
- **Protect** the power cord from being walked on or pinched, particularly at the outlet plugs, convenience receptacles, and the point where it exits the unit.
- **Only** use attachments/accessories specified by the manufacturer.
- **Always** operate this equipment from a 120/230 volts 1 phase, 60Hz power sources only. (220/240 volts / 1 phase/ 50Hz models)
- **Always** ground the outlet to provide adequate protection against voltage surges and built-up static charges.
- **Refer all** servicing to qualified service personnel. Servicing is required when the unit has been damaged in any way.

Installation

 **CAUTION** 
SHARP EDGES
RISK OF SERIOUS INJURY

Sharp edges are present inside the Wine Guardian system.

Pre-installation Test

Test the system before installing it to check for non-visible shipping damage.

To test the Wine Guardian fan coil section:

- ✓ Set the system on the floor or a sturdy level surface.
- ✓ Plug in the system.
- ✓ Press the on/off switch to see if the control illuminates. This indicates the system has power.
- ✓ **A built-in timer within the controller prevents short cycling and keeps the system from turning on right away.** After a five-minute period, the fan should turn on and start to deliver air. Listen for any unusual noise or vibration.

Air Flow Diagram

Fig. 1

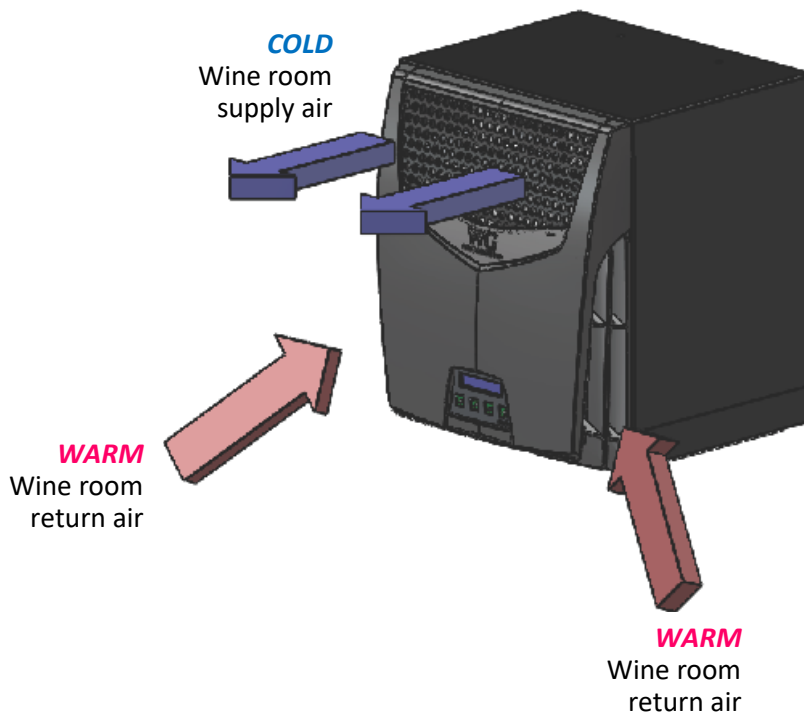



WARNING



RISK OF PERSONAL INJURY OR DAMAGE TO EQUIPMENT

Modification to the equipment may cause injury or damage to the equipment



DANGER



- ✓ **This equipment is heavy. Place the unit on the floor or on a level and stable surface that can support the full weight of the unit.**
- ✓ **Do not modify the equipment. Modifications may cause damage to the equipment and will void the warranty.**
- ✓ **Never place anything on top of the unit.**
- ✓ **Never block or cover any of the openings or outlets to the unit.**
- ✓ **Never allow anything to rest on or roll over the power cord.**
- ✓ **Never place the unit where the power cord is subject to wear or abuse.**
- ✓ **Do not use extension cords.**
- ✓ **Never overload wall outlets.**
- ✓ **Do not remove or open any cover unless the unit is turned off and the power cord is plugged in.**
- ✓ **Use only dedicated power outlet boxes of the correct capacity and configuration for the unit model.**



CAUTION



RISK OF PERSONAL INJURY OR DAMAGE TO EQUIPMENT

Improper installation may result in the equipment malfunctioning and a safety hazard. Read all installation instructions before installing the Wine Guardian unit.

Installing the Fan Coil Unit

IMPORTANT

Installation of residential and commercial ductless split systems must be performed by qualified service technicians with proper training in the installation, start up, service, and repair of these systems. Certification to handle refrigerants is also required.

Wine Guardian fan coil units can be installed through-the-wall of the wine cellar or surface mounted on the wall within the cellar.

Provide ample clearance around the unit to access for unit maintenance.

The fan coil unit can be located either above, or below the condensing unit in height. Wine Guardian strongly suggests that any height difference be kept to a minimum.

The fan coil unit is equipped with an On/Off switch, two communication ports, and an optional humidifier connection. Communication ports can be used for other factory options, such as remote temperature/humidity sensors.

Planning the fan coil installation

Tools required



Wine Guardian systems are typically installed at the user's eye level for ease of operation. The Wine Guardian ductless fan coil can be mounted through-the-wall, which creates a flush wall mounted appearance or it can be surface mounted on the wall so that the face of the unit is flush with the racking. The fan-coil can also be mounted above a doorway for applications where there is limited free wall space for a cooling unit. When determining the location, consider the routing and location of the refrigerant piping, condensate drain, control wiring and power cord.

IMPORTANT

The back side of the fan-coil unit may become unsightly with connections for refrigerant piping, primary power, control wiring and condensate drain. Consideration should be given to unit placement adjacent to finished walls when considering a Through-the-wall installation. The back side of the unit may need to be hidden or an access panel provided for a finished appearance.

- ✓ Where to locate the unit? *Location is usually predicated by the racking that can be reached for control panel access.*
- ✓ How to mount the unit? *Use the Wine Guardian supplied sleeve for through-the-wall installation and our surface mount bracket for surface mount installations.*
- ✓ Locate the electrical power outlet close to the unit in the cellar. **Do not use an extension cord!**
- ✓ Where to run the refrigerant lines? *Maximum line length is 50' with a maximum elevation rise of 30'. Minimize 90-degree bends and keep condensing unit as close to fan coil as possible.*
- ✓ Where to locate the thermostat, if remote interface control is ordered? *Thermostat should be located midpoint on a wall within the wine cellar and provide sufficient access and exposure to airflow.*
- ✓ How to install the drain line? *Run to an open floor drain, container, or condensate pump.*
- ✓ Are all the parts here to complete the installation? *Installation sleeve, gasket, sealant fasteners, surface mount bracket.*

Mounting the System

Follow the steps below for surface mounting or through-the-wall mounting of the fan coil



RISK OF PERSONAL INJURY OR DAMAGE TO EQUIPMENT

Ensure that the area chosen does not have electrical or plumbing interference within the wall or along the outside of the wall. Failure to do so could cause property damage or personal injury. If the wall does include electrical wiring or plumbing DO NOT CONTINUE. Contact a qualified electrician or plumber to relocate these services or choose an alternate location for mounting the WG system.

<i>Through-the-Wall Mounting of the Fan Coil</i>	<i>Surface Mounting of the Fan Coil</i>
<p>Step 1</p>  <p>Find wall stud locations. If both wine cellar side and finished basement side of walls have drywall already installed it is important to locate the wall studs in the area chosen to mount the Through-the-Wall system. Use of any high quality stud finder is recommended for locating the center and edges of the wall studs on the wine cellar wall. Once located, the stud edges should be clearly marked prior to following Step 2 below.</p>	<p>Step 1</p>  <p>Find wall stud locations. If both wine cellar side and finished basement side of walls have drywall already installed it is important to locate the wall studs in the area chosen to mount the Through-the-Wall system. Use of any high quality stud finder is recommended for locating the center and edges of the wall studs on the wine cellar wall. Once located, the stud edges should be clearly marked prior to following Step 2 below.</p>
<p>Step 2</p>  <p>Preparing wall penetration for EasyMount™ sleeve. Mark the penetration dimensions on the wall (wine cellar and finished basement side) at the desired mounting location for the Wine Guardian fan-coil. Keep in mind the ideal height should be at eye level to the user. The unit controls should be reachable upon installation completion. The wall penetration should be no more than 14-1/2" wide by 16-1/4" high (36.83cm wide by 41.27cm high) stud-to-stud dimension. Modification of stud locations should not be required.</p>	<p>Step 2</p> <p>Prepare the wall mounting area by marking the bracket mounting location on the wall. Securing the bracket directly to wall studs (as marked in Step 1). Failure to mount to studs will require the use of the appropriately sized anchors to secure the bracket. The Wine Guardian fan-coil weighs 25 lbs.</p>
<p>Step 3</p>  <p>Slide the EasyMount™ sleeve through the wall penetration so that the flanged area of the sleeve sits flush with the surface of the wall. Ensure the EasyMount™ sleeve is level and plumb prior to fastening to the existing studs.</p> <p>New Design EasyMount™ Sleeve The new design EasyMount™ sleeve is fastened through four (4) holes located on either side of its front flange, as shown on right.</p>  <p>IMPORTANT</p> <p>The Installation Sleeve must be installed level within the wall opening to provide proper operation of the Wine Guardian system. Failure to do so may result in improper drainage, excessive wear, vibration and noise.</p>	<p>Step 3</p> <p>With the template provided mark the hole required through the wall for the refrigerant piping, condensate drain and control wiring to be routed to the condensing unit and drain system.</p>

<i>Through-the-Wall Mounting of the Fan Coil</i>	<i>Surface Mounting of the Fan Coil</i>
<p>Step 4 Insert screws into upper pre-drilled hole on both sides of sleeve, continue to lower set of holes. Ensure screws are flush with wall sleeve. Do not over tighten.</p>	<p>Step 4 Cut hole in wall as marked in Step 3 and route utilities for connection to unit. Provide enough refrigerant tubing, control wire and drain tubing within wine room for proper connection to fan-coil unit. Note- penetration through wall should be seal once the utilities have been successfully routed.</p>
<p>Step 5 Slide the Wine Guardian Ductless Split System through the EasyMount™ sleeve to the desired depth. Please note the power cord may need to be pushed through sleeve prior to sliding the Wine Guardian Through-the-Wall system unit into sleeve (with pipe bender).</p>	<p>Step 5 Carefully bend down (with pipe bender) the refrigerant tubing from the back side of the fan-coil. Inspect both suction and liquid lines for any foreign material or debris and ready tubing for braise connections. Tubing may be cut down to fit location, with caution, to leave proper clearance. Failure to leave clearance may result in damage to the fan coil.</p>
<p>Step 6 Carefully bend down the refrigerant tubing from the back side of the fan-coil. Inspect both suction and liquid lines for any foreign material or debris and ready tubing for braise connections. Tubing may be cut down to fit location with caution to leave proper clearance for braising. Failure to leave clearance may result in damage to the fan coil.</p>	<p>Step 6 Temporarily support the fan-coil section close to the utility connections at the wall and Braise the suction and liquid lines to the field connections.</p>
<p>Step 7 Braise suction and liquid lines to field connections</p>	<p>Step 7 Connect control wire to terminal strip</p>
<p>Step 8 Connect 24-volt control wire to terminal strip and route to remote condensing unit</p>	<p>Step 8 Connect condensate drain line to the drain tube at the back of the fan-coil</p>
<p>Step 9 Connect condensate drain and run to open floor drain, open sink or condensate pump</p>	<p>Step 9 Hang fan-coil to wall mounted bracket</p>
<p>Step 10 Plug in power cord to dedicated electrical receptacle</p>	<p>Step 10 Plug in power cord to dedicated electrical receptacle.</p>

Installing the Condensate Drain Connection

The Wine Guardian unit provides dehumidification for the inside of the wine cellar. It cools the air down to the dew point corresponding to the temperature setpoint of the local user interface. If the vapor barrier of the wine cellar is poorly constructed or excess moisture is in the basement, the unit may remove excessive amounts of moisture from the wine cellar. The moisture appears in the condensate drain of the unit.

NOTE: If moisture becomes excessive, install a room type dehumidifier to dehumidify the basement so as to not overload your Wine Guardian.

Installing the Drain Line

- ✓ The factory supplied drain line must extend from the unit to an external drain or disposal site. Do not use drain tubing any smaller than one-half inch inside dimension on the unit.
- ✓ If needed, splice a drain extension onto the drainline with a short piece of one-half inch (1.27cm) – outside diameter – copper tubing and secure with clamps.
- ✓ If no drain is available, use a bucket. Do not extend the drain below the rim of the bucket. Empty the bucket periodically.

The Wine Guardian unit does not have an internal trap. A trap must be provided within the drain line for proper draining of the unit.

Allow enough height for the drain line to function properly. If draining into a nearby sink, the unit must be elevated higher than the rim of the sink in order for the water to drain by gravity. Install with a one-quarter inch per linear foot of pitch. **Do not** tie the condensate drain line directly into the sanitary sewer system. See Accessories and Optional Equipment on page 6 for information about the condensate pump.

Priming the Drain

The internal drain primes itself automatically once the unit has run for a period of time and after the unit cycles off. This can be confirmed by water dripping from the drain.

Wiring the Fan Coil Unit for Power



DANGER
ELECTRICAL SHOCK HAZARD
RISK OF SERIOUS INJURY OR DEATH

The electrical outlet and wiring installation must meet the national and local building codes.

DO:

- ✓ Match the electrical wiring to the cord provided on the Wine Guardian.
- ✓ Provide dedicated circuit and wiring for the system.
- ✓ Match the wiring and breaker size to the rated load as shown on the serial plate and in this guide. See sample serial plate illustration below.

P/N: 99H0292-00		Serial # INPUT
Model #INPUT	WINE GUARDIAN	Rev: INPUT
Electrical	115/1/60	Electrical Heat Amps (opt) 4.35
Evaporator Fan Amps	0.7	Humidifier Amps (opt.) 0.3
Total Unit Amps (w/o opt)	0.7	Crankcase Htr Amps (opt) 0.13
Min. Circuit Amps (w/o opt)	0.88	Refrigerant R-134A
		Test Pressure 275 psi
Maximum outlet air temperature	68.5 F	
Maximum spacing to combustible materials	6"	
Air Innovations, 7000 Performance Dr. North Syracuse NY 13212 Ph: 800-825-3268 *315-452-7400 http://www.airinnovations.com		

DO NOT:

- ✓ DO NOT MODIFY THE PLUGS IN ANY WAY!
- ✓ Do not use extension cords.

IMPORTANT

The electrical power supply must be either 115 volt or 230-volt AC, 1 phase 60Hz, for model SS018 and 220/240 volt, 1 phase 50 Hz for model WGS25.

This cannot vary more than plus or minus 4% or damage may occur to the unit.

Plug the unit into the wall outlet. Gently pull on the plug to make sure it is tight. Drawing below for 60Hz model – SS018. For 50Hz model – WGS25 see wiring diagram on page 12 of this manual.

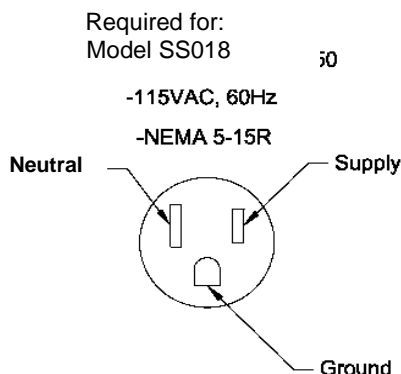

Installing the Condensing Unit

- Condensing units are factory assembled with a sheet metal outdoor enclosure for protection from the elements.
- A minimum of 12 inches (30cm) is required around the perimeter of the condensing unit for proper airflow across the coil, and to provide an adequate discharge airflow path through the fan motor. Any obstructions to this airflow will result in a decrease in performance, and possibly premature failure due to a buildup of high pressure within the system.
- The condensing unit is designed to operate in ambient temperatures ranging from 50°F-115°F (minus 10°C -46°C) as it is supplied with many standard features to assist full operation in this wide range. If required to operate in lower ambient conditions, it is recommended that you order the low ambient option model condensing unit.
- Mount the condensing unit above normal snowfall levels, to allow uninhibited winter operation. A buildup of snow or any obstruction to airflow will result in a decrease in performance and possible premature failure due to an increasingly high pressure within the system.

Installation of Interconnecting Refrigerant Lines (Suction and Liquid)

NOTE: The interconnecting copper refrigerant lines shall be supplied by the installer. The larger suction line must be fully insulated along its complete length from condensing unit to fan coil unit. There is a factory-installed liquid line filter-drier inside the condensing unit; therefore, no additional drier is needed for proper operation. A liquid line moisture/sight glass is factory installed in the condensing unit to assist in monitoring the refrigerant charge, and the state of the refrigerant in the system.

- Keep horizontal and vertical distances between the indoor and outdoor section as close as possible to minimize refrigerant charge required. This will reduce system issues related to oil management that can impair performance and jeopardize the compressor's lubrication.
- Provide a one-inch pitch in suction and liquid line toward the evaporator for every 10 feet (3 meters) of run to prevent any refrigerant that condenses in the suction line from flowing to the compressor when the unit is off. These two lines can be routed together and wrapped together, as long as the suction line is fully insulated as previously directed.
- Suction line riser traps are not required if the riser is properly sized to maintain refrigerant velocity. Adding a trap will only increase pressure drop.
- Prevent dips, sags, or other low spots that will trap refrigerant oil, which is an issue especially with long horizontal runs. Use hard refrigerant copper for longer horizontal runs to prevent potential oil return problems. (see sample piping chart on page 25)
- When sweat connections are made in the connecting lines, be sure that the inside of the tubing is clean before installing the unit. Use a dry nitrogen bleed during brazing. Note that compressor suction and discharge valves should be open to atmosphere no longer than 15 minutes. Compressors with POE (polyolester) oil will quickly become contaminated when opened to atmosphere.

NOTE: The suction line should be clamped near the inlet end of the vibration eliminator. The vibration eliminator is located between the clamp and the compressor.

Split System Interconnecting Line Sizing Chart

Table 3

Model	Liquid Line(OD)	Liquid connection at evaporator (OD)	Suction line (OD)	Min. Suction line insulation thickness	Suction connection at evaporator (OD)	Maximum "total" line length	Maximum lift (height)
SS018 & WGS25	1/4 inch 6.35mm	1/4 inch 6.35mm	5/16 inch 7.93mm	3/8 inch 9.52mm	3/8 inch ** (reduced) 15.24 meters (reduced)	50 feet 15.24 meters	15 feet 4.52 meters

**** Reduced to accept 5/16" (7.93mm) O.D. interconnecting suction line.**

Notes:

- **Line lengths are expressed in equivalent feet/meters = actual run length + fitting allowances (i.e. ~5 feet or 1.5 meters for each bend/elbow allowance).**
- **Use only refrigeration grade dehydrated tubing.**
- **Install refrigeration piping per local codes and ASHRAE guidelines.**

Sample Piping Configurations

Incorrect Installation

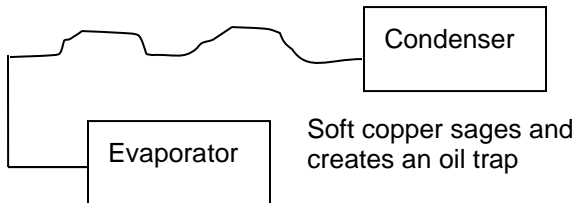
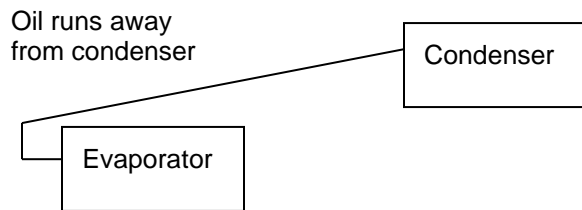
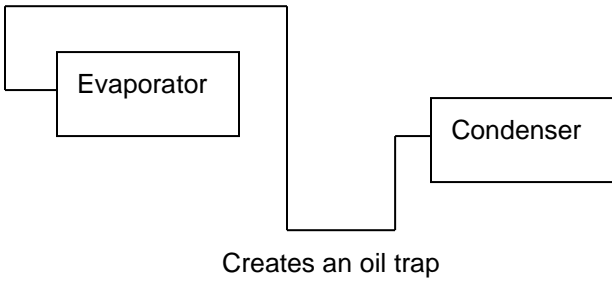
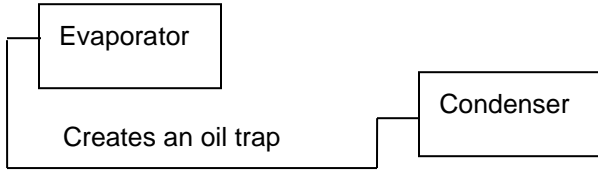

Correct Installation

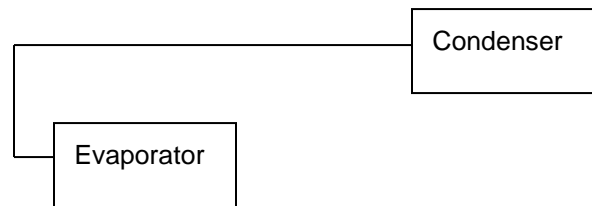
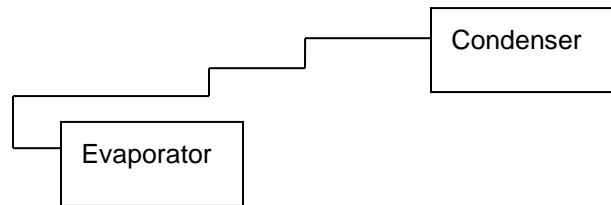
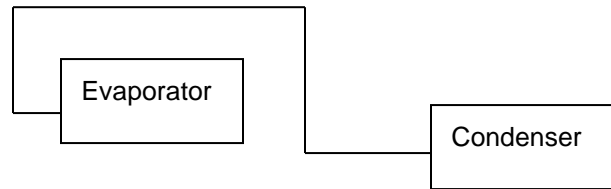
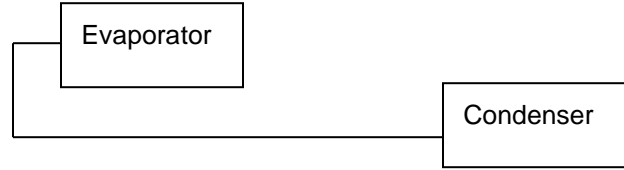

Leak Checking and Evacuation Process

- Pressurize and leak test the interconnecting lines, including the fan coil unit, fittings, and brazed joints using the intended operating refrigerant, nitrogen, or dry air for leak testing. A pressure equal to the low side test pressure marked on the unit nameplate is recommended for leak testing. Repair any leaks found. Connect a good vacuum pump to both the low and high side service valves while still in their factory supplied position, isolating the refrigerant charge in the condensing unit. Draw a deep vacuum of at least 15pp microns. Do not use the motor compressor to pull a vacuum and do not operate the motor compressor in a vacuum.
- Evacuate the system to hold at 500 microns and break the vacuum by releasing the factory refrigerant charge in the condensing unit to interconnect lines and fan coil unit by opening service valves. Remove the vacuum pump. The system is now ready for optimal charging. The condensing unit comes pre-refrigerant charged for 10 feet (3 meters) of interconnecting tube. Charge the system with the correct amount of refrigerant and mark the amount, with a ballpoint pen, in the space provided on the unit nameplate.

See Interconnecting Line Sizing Chart on page 24 for approximate additional amount to add beyond 10 feet interconnecting tubing.

NOTE: When charging through the suction service valve the refrigerant should be charged in vapor form. NEVER CHARGE IN LIQUID FORM. Refrigerant should always be charged through a dryer. Charging in liquid form may damage the valve plate assembly as well as scrub the oil out of the compressor bearings.



NON-AZEOTROPES MUST BE CHARGED IN THE LIQUID PHASE ONLY. TO AVOID COMPRESSOR DAMAGE, LIQUID MUST ALWAYS BE CHARGED INTO THE HIGH SIDE OR INTO AN ACCUMULATOR.

NOTE: Be sure there is not an overcharge of refrigerant. An overcharge might permit liquid refrigerant to enter the motor compressor and damage the valves, rods, pistons, etc.

Wiring

- Wire the system as per the supplied wiring schematic found on pages 11 and 12 of this manual.
- The fan coil unit is powered through a factory-supplied power cord, but you will need to run 24-volt power wires from the low voltage terminal block on the fan coil to the factory supplied low voltage leads in the condensing unit. This can be typical controller wire or 18 gauge insulated wire.
- The condensing unit needs to be hard-wired for the rated high voltage to be brought to the factory-installed contactor in condensing unit enclosure from the line side (L1 & L2) of the contactor. Run a ground lead to be connected to the condensing unit Ground lead/LUG. The load side of the factory-installed contactor will be factory-wired.
- For low ambient models, turn on power to the condensing unit 24 hours prior to system start-up to allow crankcase heater to warm up compressor crankcase.

Refrigerant Charging – for low ambient models only

NOTE: The SS018 and WGS25 with low ambient option utilize a Headmaster control valve to control head pressure at low ambient applications, therefore require a specific initial charging procedure as outlined below.

Determining the amount of charge – When “refrigerant side” head pressure control is utilized on a system, one of the most important factors is determining the total system refrigerant charge. While on most packaged units the amount of charge is listed on the unit, the required charge for a field built-up system cannot be listed by the manufacturer. Charge is usually added when the system is started up until “proper” system performance is reached. However, this is not satisfactory and if the system is to function properly year-round, the correct amount of extra charge must be calculated ahead of time.

Procedures for Charging System with Low Ambient Option (Head Pressure Control)

(SS018 and WGS25 Low Ambient Options only)

NOTE: When charging any system with head pressure control the outdoor ambient temperature must be known.

**Charging of Systems with Head Pressure Control in temperatures above 70° F (21°C) --
After normal evacuation procedures:**

1. Connect refrigerant cylinder to liquid line service valve port.
2. Charge liquid refrigerant into the high side of the system. Weighing the charge is recommended.
3. Remove the refrigerant drum and connect it to the suction service valve.
4. Charge refrigerant vapor into the low side. Do not allow **liquid** refrigerant into the low side.
5. Start the system.
6. Observe sight glass (factory-installed) to see if system is filling with refrigerant for normal refrigeration cycle.



BUBBLES IN THE SIGHT GLASS CAN BE CAUSED BY FLASHING DUE TO PRESSURE DROP FROM PIPE OR ACCESSORY LOSSES, ETC.

7. If the **Sight glass** shows bubbles, more refrigerant may be required, while allowing sufficient time for the refrigerant to stabilize and clear the **Sight glass**. Use supplied information on the following pages for proper final charge.

Charging of Systems with head pressure Control in temperatures below 70° F (21°C) (After normal evacuation procedures):

NOTE: When charging in ambient below 70°F (21°C) the procedure is very critical. Be sure to adhere to the following steps. Failure to do so will result in overcharging the system.

1. Follow instructions 1 through 7 above.
2. If the valve setting is correct for the system being charged, it is quite likely that some refrigerant will be backed up into the condenser and the **Sight glass** will indicate bubbles in the liquid line.
3. Add more refrigerant, while allowing sufficient time for the refrigerant to stabilize and clear the **Sight glass**. Use supplied information on the following pages for proper final charge.
4. At this point the system is correctly charged for this type of head pressure control at the ambient temperature that exists while the charging procedure is taking place.
5. If the system is designed to operate at ambient below the ambient that exists during charging, additional charge may have to be added now.

Good system performance during low ambient operation depends on proper refrigerant charge, therefore, it is very important that this phase of the installation procedure be done carefully.

Poor system performance is often caused by over or under charging of refrigerant and may be the most overlooked.

With the system started

- After following instructions on the previous page Charging for Systems with Head Pressure Control, with refrigerant tank now connected to suction line (low side) port to add remaining charge in a gas state, refer to the provided charts for proper system operating points as equated to ambient temperature with wine cellar at normal conditions of 57° F (13°C) / 55%RH. Refer to Split Systems Operations chart on page 31 for system pressures, sub-cooling, and superheat values to allow you to charge your system correctly.
- In addition to using the Systems Operations Chart, there is a liquid line moisture/sight glass located in the condensing (outdoor) unit as a useful guide to help determine if the system has been sufficiently charged. HOWEVER, a full sight glass or a glass with bubbles does not necessarily indicate the system is properly charged, or undercharged. There may be other factors affecting sight glass, so do not charge by sight glass method only. A full sight glass-matched with proper system pressures, sub-cooling, and superheat values is the proper method for confirming that the system charge is correct for your application.

If you are not sure how to measure superheat or sub-cooling:

Superheat

- Get an accurate suction line temperature on the suction line as close to the compressor inlet as possible. At same time, attach a compound pressure gauge set to the system so as to read the low side suction pressure at the suction service valve port (back seated valve stem to allow un-restricted refrigerant flow from evaporator back to the compressor). Convert suction pressure to a saturated temperature as derived from a pressure/temperature chart. Since the suction line temperature is the higher value, subtract the saturated temperature from it to derive your superheat. If your wine cellar is already at specified conditions e.g., 57° F (13°C), 55% RH), and if your superheat is very low, or zero, you may have overcharged your system.

Sub-Cooling

- With your compound pressure gauge set still installed with the high side connect to the valve port on the liquid receiver (back seated valve stem to allow un-restricted refrigerant flow from condenser to evaporator). Convert this liquid pressure to a saturated temperature from pressure/temperature chart. Next, obtain your liquid line temperature by getting an accurate reading on the liquid line BEFORE the TXV expansion on the indoor side. Obtain this temperature entering the evaporator unit. Subtract the liquid line temperature from the saturated liquid temperature to derive the system sub-cooling.

When comparing your high side system pressure to supplied charts below, refer to the liquid line pressure.

To give you an idea on how much R134A refrigerant charge you may require to reach full charge for your given interconnecting line length, see the very general guidelines below based on liquid line size:

SS018 ¼” OD ~ .50 ounce/foot
WGS25 ¼” OD ~ 46 grams/meter

**Based on factory testing using 25 feet (7.6 meters) of interconnected piping

	Shipped Before 8/1/2019	Shipped Before 8/1/2019
SS018	47 ounce total charge	16 ounce total charge
WGS25	50 ounce total charge	16 ounce total charge

SS018 = 47-ounce total charge
WGS25 = 50-ounce total charge / 1417 grams

Split System Operations Chart

SS018

OD Ambient (F)	Suction (psig)	Discharge (psig)	Superheat (F)	Sub-cooling (F)
10F	27	100	4	6
40	27	103	5	5
60	27	108	8	18
70	28	110	12	18
80	28	112	15	17
100	30	145	18	18
115	36	180	7	19

***Low ambient option must be ordered and installed at the factory

WGS25

OD Ambient (C)	Suction (kPa)	Discharge (kPa)	Superheat (C)	Sub-cooling (C)
-12	186	689	-16	-14
4	206	710	-14	-7
15	213	730	-10	-13
21	206	758	-10	-7
27	220	772	-14	-8
32	234	1006	-1	-7
46	234	1247	-1	-6

***Low ambient option must be ordered and installed at the factory

Starting-up and Operating the Wine Guardian

Control Settings



The control has been wired and set up in the factory for testing with default settings. It is an electronic digital thermostat for single-stage cooling. No additional adjustments should be necessary except adjusting the cellar temperature to your preference. If additional adjustments or changes are necessary, please refer to the configuration settings section in this manual.

Controller Functions

ON/OFF – The ON/OFF button will be used to turn the system on or off. When set to the off mode the control will not allow any of the outputs to energize effectively locking the system out. It will not allow any outputs to energize until the system is turned on with the ON/OFF button. It should be noted that high voltage will still be present at the main control board when the system is set to off even though the control will not allow it to switch to the outputs.

UP Arrow – The UP arrow will allow the user to increase settings.

DOWN Arrow – The DOWN arrow will allow the user to decrease settings.

SETTINGS – The setting button will be used to select between HEAT, COOL and AUTO MODE, as well as entering the configuration settings. Holding the SETTINGS button for 5 seconds will enter configuration mode. Once in configuration mode the user can adjust settings by pressing the UP or DOWN arrows. Pressing the SETTINGS button once will advance to the next configuration settings. Holding the SETTINGS button for 5 seconds while in configuration mode will store all changes and exit configuration mode.

For cooling operation only: Cooling for **60Hz models** is set at 55°F from the factory and 13°C for **50Hz models**. This can be changed by hitting the UP or DOWN arrow, but please refer to configuration settings # 2 and # 3 for limitations in comparison to the High and Low temperature alarm settings.

For units with optional humidifier controlled by SS018 WG: The RH% is factory set at 55%. This can be changed by referring to configurations setting # 6. If no humidifier is attached, the control will read RH%, but will not be controlling it.



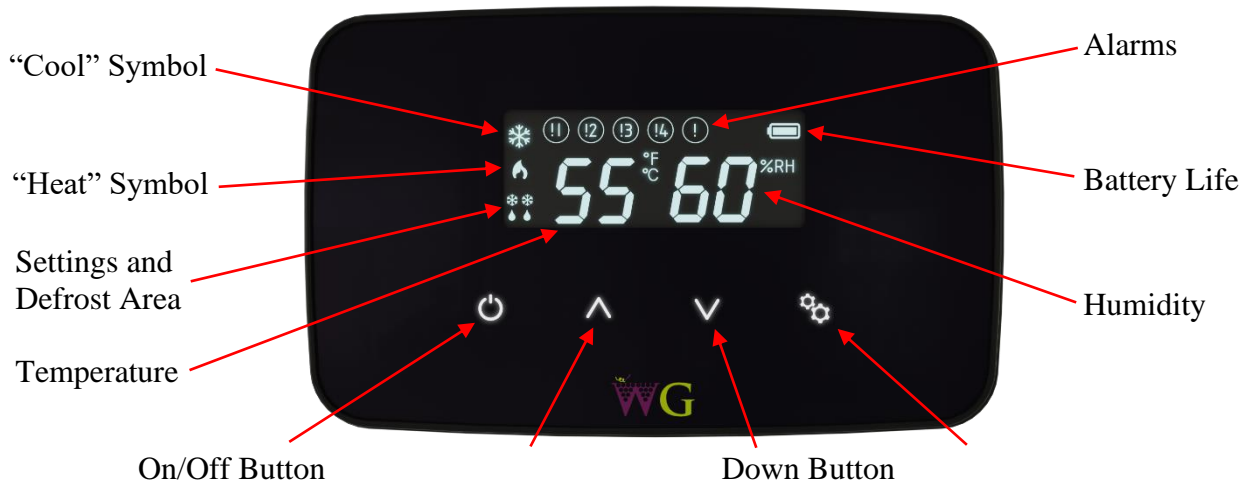

Changing fan operation: The default setting from the factory is “AUTO” fan. If desired it can be changed to fan “ON” by accessing configuration setting # 7.

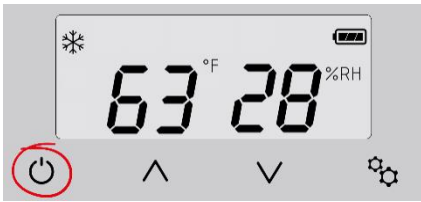
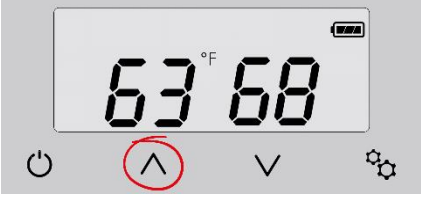
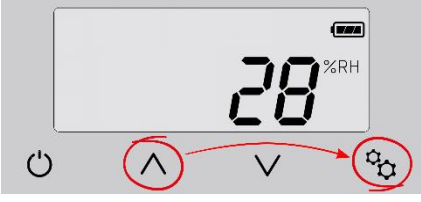
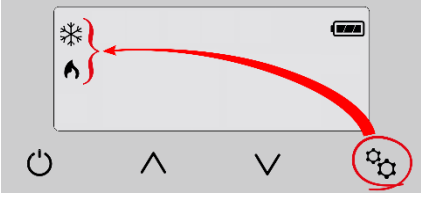

Standard Controller Functions

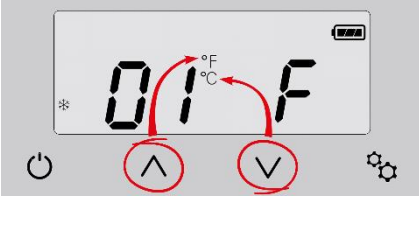
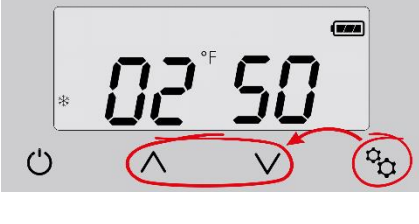

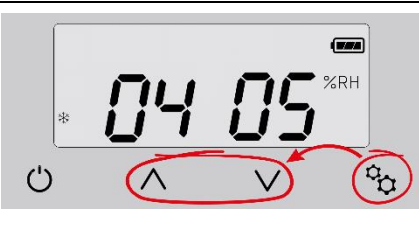
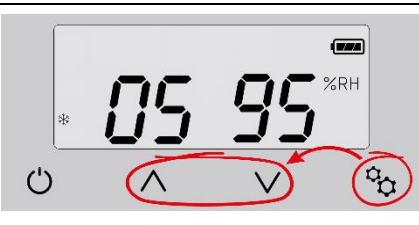



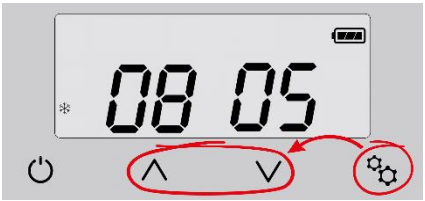

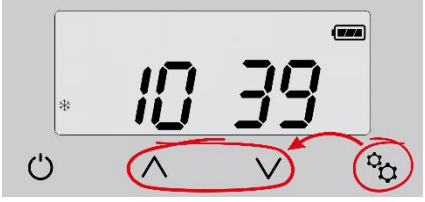

<i>How to:</i>		
<p>Turn system on/off</p>		<ul style="list-style-type: none"> • Press the “On/Off” button once. <p>Note: There is a five (5) minute time delay before the system turns on or turns off.</p>
<p>Change temperature</p>		<ul style="list-style-type: none"> • Press the “Up” arrow once. The display will show the existing temperature setpoint. • Press the up or down arrow buttons to adjust the temperature to the desired set point.
<p>Change humidity</p>		<ul style="list-style-type: none"> • Press the “Up” arrow once. This display will show the existing temperature setpoint. • Press the “Settings” button once to display the “Humidity” setpoint. • Press the “Up” or “Down” arrows to adjust the humidity to the desired set point. <p>Note: A Wine Guardian humidifier must be installed and Setting 6 set to “1” or “2” before the controller will let you change percent humidity.</p>
<p>Change Settings Cooling/ Heating / Auto</p>		<ul style="list-style-type: none"> • Press the Setting button once to display the setting function at the bottom of the screen. • Press the Settings button again to scroll through settings for cool only, heat only or heat/cool only – auto mode.





Settings – Press and hold the “Settings” button for five (5) seconds to access the following settings.



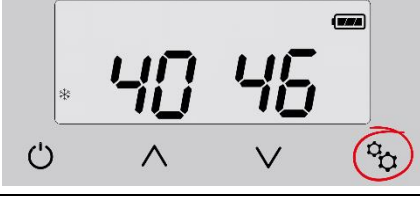

<p>Degrees F or Degrees C</p>		<p>Setting 1</p> <ul style="list-style-type: none"> • Press the “Up” arrow to change temperature from °F to °C. • Press the “Down” arrow to change temperature from °C to °F.
<p>Low temperature alarm setpoint</p>		<p>Setting 2</p> <ul style="list-style-type: none"> • Press “Settings” button to advance to Setting 2. • Press the “Up” or “Down” arrow buttons to adjust to the desired setpoint. Factory default is 50°F (10°C).
<p>High temperature alarm setpoint</p>		<p>Setting 3</p> <ul style="list-style-type: none"> • Press “Settings” button to advance to Setting 3. • Press the “Up” or “Down” arrow buttons to adjust to the desired setpoint. Factory default is 65°F (18°C).
<p>Low humidity alarm set point</p>		<p>Setting 4</p> <ul style="list-style-type: none"> • Press “Settings” button to advance to Setting 4. • Press the “Up” or “Down” arrow buttons to adjust to the desired setpoint. Factory default is 5%.
<p>High humidity alarm setpoint</p>		<p>Setting 5</p> <ul style="list-style-type: none"> • Press “Settings” button to advance to Setting 5. • Press the up or down arrow buttons to adjust to the desired setpoint. Factory default is 95%.
<p>Add or remove humidifier</p>		<p>Setting 6</p> <ul style="list-style-type: none"> • Press “Settings” button to advance to Setting 6. • Press the “Up” or “Down” arrow buttons to adjust to the desired setpoint. Factory default is zero (0). <p>Zero (0) = No humidifier One (1) = Integral Wine Guardian mounted humidifier Two (2) = Stand-alone remote mounted humidifier</p>

<p>Fan AUTO or ON</p>		<p>Setting 7</p> <ul style="list-style-type: none"> • Press “Settings” button to advance to Setting 7. • Press the “Up” or “Down” arrow buttons to adjust number to the desired set point. Factory default is zero (0). Zero (0) = Auto–fan only turns on when there is a call for cooling or heating One (1) = Fan On–fan remains on continuously
<p>Compressor anti-short cycling</p>		<p>Setting 8</p> <ul style="list-style-type: none"> • Press “Settings” button to advance to Setting 8. • Press the “Up” or “Down” arrow buttons to adjust to the desired time in one-minute increments. Maximum is 10 minutes; minimum is 3 minutes. Factory default is 5 minutes. <p>Compressor anti-short cycling time is the amount of allowable time between compressor stop and restart. Rapid start/stop of compressors can cause premature failure.</p> <p>WINE GUARDIAN DOES NOT RECOMMEND SETTINGS LOWER THAN FACTORY DEFAULT.</p>
<p>Defrost sensor enable/disable</p>		<p>Setting 9</p> <ul style="list-style-type: none"> • Press “Settings” button to advance to Setting 9. • Press the “Up” or “Down” arrow buttons to adjust to the desired setpoint. 1 will equal enabled and a 0 (zero) will equal disabled.
<p>Defrost cut-in temperature</p>		<p>Setting 10</p> <ul style="list-style-type: none"> • Press "Settings" button to advance to Setting 10. • Press the “Up” or “Down” arrow buttons to adjust to the desired setpoint. This setting is adjustable from 25°F to 40°F. Factory default is 39°F. <p>There must be at least a 1°F difference between defrost cut-in and cut-out set points.</p>

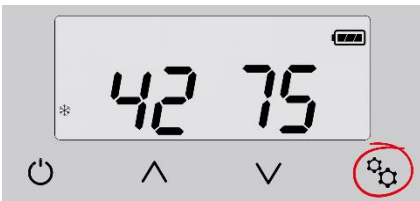
<p>Defrost cut-out temperature</p>		<p>Setting 11</p> <ul style="list-style-type: none"> • Press "Settings" button to advance to Setting 11. • Press the "Up" or "Down" arrow buttons to adjust to the desired setpoint. This setting is adjustable from 35°F to 50°F. Factory default is 40°F. <p>Note: This setpoint must be 1°F/°C higher than setting 10.</p> <p>Note: If °C is selected and then switched back to °F the default cut-out will change to 41°F.</p>
<p>Defrost check interval</p>		<p>Setting 12</p> <ul style="list-style-type: none"> • Press "Settings" button to advance to Setting 12. • Press the "Up" or "Down" arrow buttons to adjust to the desired setpoint. This setting is adjustable from 30 min at 0 (zero), 1 hour at 1, and then in 1 hour increments up to a maximum of 12 hours at 12.
<p>Room temperature offset</p>		<p>Setting 13</p> <ul style="list-style-type: none"> • Press "Settings" button to advance to Setting 13. • Press the "Up" or "Down" buttons to adjust to the desired set point. Maximum setting is +5°F, minimum setting is -5°F. Factory default is zero (0). <p>Room temperature offset changes the actual display reading (temperature only) by the value of this setting.</p> <p>Example: Sensor reading = 55°F (13°C) Setting 15 set to +4 Display reading = 59°F (15°C)</p>
<p>RH offset</p>		<p>Setting 14</p> <ul style="list-style-type: none"> • Press "Settings" button to advance to Setting 14 • Press the "Up" or "Down" buttons to adjust to the desired setpoint. This setting allows the adjustment of %RH reading by +/-10%. Factory default is 0%RH.

<p>Compressor run temperature offset</p>		<p>Setting 15</p> <ul style="list-style-type: none"> • Press “Settings” button to advance to Setting 15 • Press the “Up” or “Down” buttons to adjust to the desired setpoint. This setting changes the system/compressor turn-on temperature above setpoint. Factory default is 1°F. <p>Example: Sensor reading = 55°F (13°C) Setting 17 set to +3°F System/compressor turns on at 58°F (14°C)</p>
<p>Temperature deadband</p>		<p>Setting 16</p> <ul style="list-style-type: none"> • Press “Settings” button to advance to Setting 16. • Press the “Up” or “Down” buttons to adjust to the desired setpoint. This setting is the minimal allowable temperature difference between heating and cooling setpoints. Maximum is 5°F (3°C), minimum is 1°F (1°C). Factory default is 2°F (1°C).
<p>Condensate switch</p>		<p>Setting 17</p> <ul style="list-style-type: none"> • Press “Settings” button to advance to Setting 17. • Press the “Up” or “Down” buttons to adjust to the desired setpoint. This setting disables or enables the Condensate switch. 0 (zero) is disabled, 1 is enabled. Factory default is 0.
<p>Reserved</p>		<p>Settings 18 & 19 Reserved for additional fields.</p>
<p>System type defaults</p>		<p>Setting 20 System setting. DO NOT CHANGE.</p>
<p>Reserved</p>		<p>Settings 21-29 Reserved for additional fields.</p>

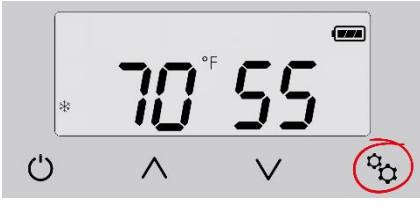
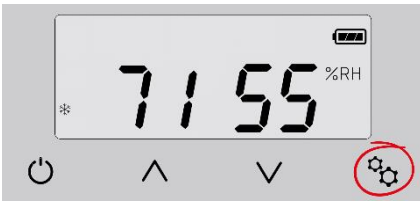
<p>Define remote user interface</p>		<p>Setting 30</p> <ul style="list-style-type: none"> • Press “Settings” button to advance to Setting 30 • Press the “Up” or “Down” buttons to adjust to the desired setpoint. <p>1 = Remote User interface #1 mounted within the wine room space and enabled 2 = Remote User interface #2 mounted within the wine room space and enabled 3 = Remote User Interface #1 disabled - will display only and can be mounted outside of wine room 4 = Remote User Interface #2 disabled - will display only and can be mounted outside of wine room</p>
<p>RF channel select</p>		<p>Setting 31</p> <ul style="list-style-type: none"> • Press “Settings” button to advance to Setting 31. • Press the “Up” or “Down” buttons to adjust to the desired setpoint. <p>Each system needs all devices to be on the same RF channel. 0 = RF disabled - system must be hardwired 1 through 12 = RF enabled and 12 channels available</p>
<p>Reserved</p>		<p>Settings 32-39 Reserved for additional fields.</p>
<p>Thermistor 1</p>		<p>Setting 40</p> <ul style="list-style-type: none"> • Press “Settings” button to advance to Setting 40. <p>No setting adjustment. Displays the supply-air temperature at coil.</p>
<p>Thermistor 2</p>		<p>Setting 41</p> <ul style="list-style-type: none"> • Press “Settings” button to advance to Setting 41. <p>No setting adjustment. Displays the return-air temperature at coil.</p>
<p>Thermistor 3</p>		<p>Setting 42</p> <ul style="list-style-type: none"> • Press “Settings” button to advance to Setting 42. <p>No setting adjustment. Displays the intake air temperature at condenser coil.</p>

Thermistor 4		Setting 43 <ul style="list-style-type: none"> • Press “Settings” button to advance to Setting 43. No setting adjustment. Displays the defrost sensor temperature.
Reserved		Setting 44-49 Reserved for additional fields.
Output test		Setting 50 <ul style="list-style-type: none"> • Press “Settings” button to advance to Setting 50. • Press the “Up” or “Down” buttons to adjust to the desired setpoint. Steps through relays as output test. 0 = Disabled 1 = Enabled
Reserved		Setting 51-69 Reserved for additional fields.
Default temperature		Setting 70 <ul style="list-style-type: none"> • Press “Settings” button to advance to Setting 70. No setting adjustment. Initial temperature set point. Will revert to this setting upon loss of power.
Default %RH		Setting 71 <ul style="list-style-type: none"> • Press “Settings” button to advance to Setting 71. No setting adjustment. Initial relative humidity set point. Will revert to this setting upon loss of power.
Default mode		Setting 72 <ul style="list-style-type: none"> • Press “Settings” button to advance to Setting 72. • Press the “Up” or “Down” buttons to adjust to the desired setpoint. Initial mode set point. Will revert to this setting upon loss of power. 1 = Auto 2 = Cool 3 = Heat

!WARNING!

Only one Unit can be set up at a time. Ensure other units are unplugged while pairing a unit to ensure there are no communication issues between Wine Guardian Units

Installing the Optional Remote Interface Controller and Communication Cable



The Wine Guardian Wireless-to-base Remote Interface Controller is a combination temperature and humidity controller with single stage cooling, heating and humidity control. It's capacitive touch screen incorporates an on/off switch, adjustment arrows and settings buttons for ease of use and programming. The controller can be installed one of two ways:

Wired (recommended) – wired directly to the Wine Guardian unit through an RJ-9 communication cable. 50' (15.25 meters) of control cable is included with each controller with longer lengths available as an option.

IMPORTANT

Whenever possible we strongly suggest wiring the Remote Interface Controller directly to the Wine Guardian unit to avoid periodic battery changes and uninterrupted service.

Wirelessly - connects wirelessly to the Wine Guardian unit by Radio Frequency connectivity through one of twelve selectable channels.

IMPORTANT

Wireless installation may result in limited communication range and connectivity issues depending upon building construction and distance between Wine Guardian unit and Remote Interface Controller and/or Remote Sensors.

The Wine Guardian Wireless-to-base Remote Interface Controller is a configurable device that can be fine-tuned through a series of individual settings. The controller incorporates an onboard temperature diagnostics system and eight (8) key temperature, humidity and system alarm points. Remote alarm indication is possible through terminal point connections at our main control board.

In most applications, the remote interface controller will be mounted within the wine cellar. The remote interface controller can also be mounted directly outside of the wine cellar or in any other room of the home or building. When mounted outside of the wine cellar, a remote sensor kit or a second wireless remote interface must be purchased and installed within the wine cellar.

IMPORTANT

Regardless of wired or wireless each, Wine guardian System can have a maximum of two (2) Remote Interface Controllers and three (3) Remote Sensors.

Controller Specification

Application	WG only, single stage cooling or heating Humidification
Programmable	No
Change over	Auto or manual, Fan ON or AUTO
Color	Black (only)
User interface	Touch screen
Auto defrost control	Yes, with Serving temp option
Connection	Communicating – RJ-9 cable
Wireless-to-base communication range	40' line of site
Wireless-to-base channels	12
Remote sensors	Yes, wired or wireless
Temperature adjustment	34 to 97 Deg F (1 to 36 Deg C)
Temperature tolerance	+/- 2 Deg F (+/- 1.1 Deg C)
Humidity adjustment	2% to 93% RH
Humidity tolerance	+/- 10% RH
System temperature diagnostics	cooling coil, condenser coil
Alarms	High temp, low temp. High humidity, low humidity. High pressure fault. Condensate, Defrost and Communication error

Mounting the Optional Remote Interface Controller (Wired)



Fig. 1



Fig. 2



Fig. 3

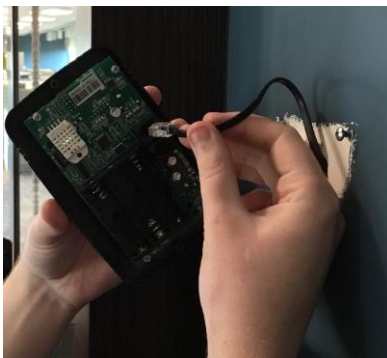

Fig. 4

1. Disconnect the communication cable from the Wine Guardian unit and the remote interface controller.
 - a. Route the communication cable within the wall and/or ceiling structure of the wine cellar to the desired controller mounting location.
 - b. Plan on mounting the remote interface controller on a solid surface away from doors, corners, air outlets, drafts or heat generating equipment. Do not mount the remote interface controller directly on an outside wall, a wall adjacent to a boiler room, or other hot area. Use a piece of foam insulation behind the sensor to insulate it from a hot or cold surface. The recommended height is four to five feet above the finished floor.
2. Remove the back plate of the controller (Fig. 1) by removing two (2) screws that hold it in place on the remote interface. Place the back plate against the wall and mark the location of the two mounting points (Fig. 2). Also mark the location of the penetration for the communication cable as this area will require sufficient clearance for the cable to exit the wall and attach to the back of the controller.
3. Drill two one-eighth inch holes and insert anchors at the marked locations. Anchors may not be required if securing to a wall stud or racking system. Insert the screws into the holes and test fit the backing plate to ensure it mounts easily onto the two screws and slides down onto the slotted opening freely (Fig. 3).
4. Re-install plastic face plate on to backing plate.
5. Plug in the communication cable to the back of the remote interface controller backing plate. (Fig. 4)
 - a. If using multiple Remote Interfaces either connect each Sensor to each other in series using RJ-9 cable or purchase a RJ-9 Splitter to be used on the unit.
6. Attach the Controller to the wall
7. Re-attach the communication cable to the back of the Wine Guardian cooling unit.

Mounting the Optional Remote Interface Controller (Wireless)



Fig. 1



Fig. 2



Fig. 3



Fig. 4

1. Disconnect the controller wire from the side of Wine Guardian unit and save for future use.
2. Plan on mounting the remote interface controller on a solid surface away from doors, corners, air outlets, drafts or heat generating equipment. Do not mount the remote interface controller directly on an outside wall, a wall adjacent to a boiler room, or other hot area. Use a piece of foam insulation behind the sensor to insulate it from a hot or cold surface. The recommended height is four to five feet above the finished floor.
3. Unscrew and remove the back plate from the Remote Interface Controller (Fig. 1)
4. Place the back plate against the wall and mark the mounting points at the desired location. (Fig. 2)
5. Drill two one-eighth inch holes and insert anchors within the mounting surface. Anchors may not be required if securing to a wall stud or racking system. Insert the screws into the holes and test fit the backing plate for mounting to ensure it mounts easily onto the two screws and slides down onto the slotted openings freely (Fig. 3)
6. Reattached the back plate to the Remote Interface Controller. (Fig. 4)
7. Insert the three AA batteries.
(only applicable with wireless installations)
8. The system will automatically acknowledge a wireless device (Remote Interface or Remote Sensor). Go to Setting "30" to define the Remote User Interface use.
9. Attach controller to the wall.

Installation of the Optional Wine Guardian Remote Sensor



The wireless remote sensor is a combination temperature and humidity sensor only. It is designed to be mounted within the wine cellar and can be used in combination with the remote interface controller or up to two additional remote sensors to read and control multiple areas within the wine cellar.

For a wired application you will require a RJ-9 communication cable.

Mounting the Wired Remote Sensor (Wired)



Fig. 1



Fig. 2

1. Disconnect the communication cable from the back of the Wine Guardian unit and the remote sensor. Route the communication cable within the wall and/or ceiling structure of the wine cellar to the desired controller mounting location.
2. Plan on mounting the remote sensor on a solid surface away from doors, corners, air outlets, drafts or heat generating equipment. Do not mount the remote sensor directly on an outside wall, a wall adjacent to a boiler room, or other hot area. Use a piece of foam insulation behind the sensor to insulate it from a hot or cold surface. The recommended height is four to five feet above the finished floor.
3. Remove the remote sensor's face plate (Fig. 1) and mark the mounting points at the desired location within the wine cellar (Fig. 2). Also, mark the location of the communication cable connection as this area will require sufficient clearance, for the cable to exit the wall and attach to the back of the sensor.

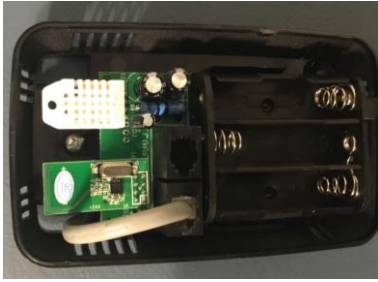

Fig. 3



Fig. 4

4. Drill two one-eighth inch holes and insert anchors within the mounting surface. Anchors may not be required if securing to a wall stud or racking system. Insert the screws into the holes and test fit the backing plate for mounting to ensure it mounts easily onto the two screws and slides down onto the slotted openings freely. (Fig. 3)
5. Plug in the communication cable to the remote sensor and mount the Remote Sensor to the wall. (Fig. 3)
7. Reattach the sensor's faceplate (Fig. 4)
8. If multiple sensors are being used either connect each Sensor to each other in series using RJ-9 cable or purchase a RJ-9 Splitter to be connected to the unit.

NOTE: Remote Sensor's will always be treated as "enabled" when hardwired. Their temperature and humidity readings will always be calculated towards the average by the system.

Mounting the Remote Sensor (Wireless)



Fig. 1



Fig. 2



Fig. 3



Fig. 4



Fig. 5

1. Disconnect the controller wire from the side of Wine Guardian unit and save for future use.
 2. Plan on mounting the remote sensor on a solid surface away from doors, corners, air outlets, drafts or heat generating equipment. Do not mount the remote sensor directly on an outside wall, wall adjacent to a boiler room, or other hot area as this runs the risk of influencing its temperature readings. The recommended height is four to five feet above the finished floor.
 3. Remove the sensor face plate (Fig. 1). Mark the mounting points at the desired location within the wine cellar (Fig. 2).
 4. Drill two one-eighth inch holes and insert anchors within the mounting surface. Anchors may not be required if securing to a wall stud or racking system. Insert screws to secure the sensor to the wall to ensure it mounts easily onto the two screws and slides down onto the slotted openings freely.
 5. Input the three AA batteries. (Fig. 3)
(only applicable with wireless installations)
 6. Pair the sensor with the unit
(See Page 46 for Pairing Instructions)
- NOTE: Once Paired the Remote Interface's readings will be included into the system's temperature and humidity averages.***
7. Mount the Remote Sensor on the wall (Fig. 4)
 8. Reattach the sensor's faceplate (Fig. 5)

Remote Sensor Pairing Instructions – Multiple Sensors (Wireless)



Fig. 1



Fig. 2

If using multiple remote temperature/humidity sensors in your application, refer to the figures and the procedure below to change each remote sensor's device number (Three Remote Sensors maximum). Each Remote Sensor must have its own device number and must also be on the same RF channel (Setting 31) as the system they are being paired with.

1. To change the remote sensor's device number, see the following instructions:
 - a. Use a pin to press the button for about half a second and release (Fig. 1).
 - b. Observe the LED on the side of the remote sensor (Fig. 2). The LED will flash once for a Device #1, twice for a #2, three times for a #3. At any time, while in this mode press the button once to change the device number. Once each remote sensor has its own unique device number simply wait for the LED to stop flashing and the setting will be saved.
2. To change the remote sensor's RF channel, see the following instructions:

NOTE: Check what RF Channel the System is set to using Setting 31 to more easily connect your Remote Sensors.

- a. Use a pin to press the red button at the back of the Remote Sensor for 5 seconds until the LED blinks rapidly then release the button.
- b. The LED will flash a number of times to portray which RF channel it is set to and repeat a total of 3 times.
- c. To change the RF channel, press the button once to increment the RF channel. There are 12 possible RF channels. All Remote Sensors will need to be on the same channel for the system to detect them. To save the RF channel setting simply wait for the mode to time out by not pressing the button.

Inspection and Start Up Checklists

Receiving and Inspecting

- Unit received undamaged
- Unit received complete as ordered including accessories

Handling and Installing

- Unit mounted on solid level surface
- Sufficient space allowed for access to unit and accessories . Proper electrical service provided
- Water provided to humidifier
- Drain line installed properly
- No obstructions to air flow around condensing unit

Starting-up the Unit

- General visual inspection looks good. All wiring connections checked
- Start unit
- Confirm condenser airflow is unrestricted
- Verify cooling and heating operation - optional
- Check for excessive noise or vibration

Starting-up and Operating the Wine Guardian Split System

Now that the installation is complete, check to make sure all tubing and electrical connections are secure.

Replace all panels that were removed during installation.



**RISK OF PERSONAL INJURY
COVER ALL OPENINGS OF THE UNIT TO PREVENT A HAND OR FINGER FROM ACCESS
INSIDE THE UNIT.**

Turn on the Unit

Plug in the unit. Press the on/off button on the local user interface. The indicator lights up to show power to the unit. The unit may not come on right away due to the timer built into the circuiting to prevent short-cycling.

Testing the Fan

(Configuration Setting 7)

Factory default is “AUTO” fan operation. To change the fan setting, refer to page 41 of this manual.

- ✓ ON means the fan runs continuously and indicates that the power is on and the control circuit is energized and operating.
- ✓ AUTO means the fan runs only when the remote interface controller is calling for cooling, heating, or the humidistat is calling for humidification.

Running the Unit

- ✓ Check unit to confirm the compressor is running, such as the hum of the compressor or cool air leaving the unit.
- ✓ Check for any unusual noise or vibration, such as clanking or rubbing.

Initially, the unit may run continuously for several hours, up to a day or more, while it lowers the cellar temperature. Once the unit reaches the setpoint temperature, it shuts off and starts to cycle on and off as it continues to lower the bottle temperature to the setpoint. The cellar air reaches set point before the bottles. If the cellar temperature started at 75°F (24°C) the supply air temperature discharged from the unit will probably be 15 to 20 degrees colder. As the cellar temperature decreases to 55°F (13°C) the supply temperature differential decreases 8 to 12 degrees colder.

NOTE: The local user interface controller will show a “Hi Temp” fault until the wine cellar temperature falls below 65°F (18°C). See page 41 for Hi Temp Alarm details.

Setting the Local User Interface Controller

Normal settings are between 54°F and 58°F (12°C and 14°C). If the optional heating coil is furnished, enter a separate temperature setting to maintain the lower setting. To prevent the unit from short cycling, the setting between heating and cooling cannot be closer than three degrees.

Regulating the Wine Cellar Temperature

Wine cellars have a natural temperature gradient of approximately 5 to 10 degrees between floor and ceiling. To increase or decrease the temperature in various zones, remove the front plastic cover and adjust the two air baffles to change the air flow patterns.

To keep the entire wine cellar at the same temperature, set the I interface controller to run the supply fan continuously and not just when the cooling is operating. Set fan switch to ON instead of AUTO.

NOTE: To monitor the cellar temperature, place thermometers in various locations in the cellar to monitor the temperature zones. Change the temperature in various zones by shifting the air flow patterns.

Maintenance

General



BEFORE PERFORMING MAINTENANCE ON THE UNIT, READ AND UNDERSTAND THE SAFETY INFORMATION CONTAINED WITHIN THE SAFETY CHAPTER OF THE WINE GUARDIAN MANUAL.



HIGH VOLTAGE - RISK OF SERIOUS INJURY OR DEATH

HIGH VOLTAGES ARE PRESENT IN THE CABINETS. TURN OFF ALL POWER. USE THE LOCKOUT/TAGOUT PROCEDURE BEFORE OPENING PANELS.



**SHARP EDGES
RISK OF SERIOUS INJURY**

SHARP EDGES ARE PRESENT ON THE FAN WHEELS, HOUSING, FINS AND COILS.

NOTE: Maintenance on Wine Guardian units requires working with high voltage and sheet metal with possible sharp edges. Only qualified personnel should perform maintenance. Some tasks require knowledge of mechanical and electrical methods. Make sure you are familiar with all hazards, general safety related procedures, and safety labels on the unit.



EXPOSURE TO MICROBIAL GROWTH (MOLD) CAN CAUSE SERIOUS HEALTH PROBLEMS

NOTE: Standing water in drain pans promote microbial growth (mold) that cause unpleasant odors and serious health-related indoor air quality problems. If mold is found, remove it immediately and sanitize that portion of the unit.

The Wine Guardian is designed for minimum maintenance. The refrigerant system is hermetically sealed and requires no maintenance. The fans are permanently lubricated and require no maintenance. Some maintenance to the unit may be required due to dust or dirt in the air stream.



**SHARP EDGES RISK OF SERIOUS INJURY
SHARP EDGES ARE PRESENT ON THE FINS AND COILS.**

Cleaning the Condensate Drain System

The condensate drain system traps dust and dirt. Clean the drain system once a year.

1. Press switch to Off and unplug the unit.
2. Make sure drain line allows free flow of water.
3. Inspect the drain pan under the coil.
4. If drain pan appears soiled, pour some hot water mixed with liquid bleach (diluted solution) along the length of the pan to flush the dirt down the drain tube.
5. Continue this treatment until the drain appears clean and free of dirt.
6. Plug in the unit and restart.

Cleaning the Humidifier (optional)

If the unit was furnished with a humidifier it requires periodic maintenance. Follow the instructions in the humidifier guide.

Heating Coil Option

The heating coil is located between the evaporator coil and blower. It contains the heating element and high temperature limit switches. The heating coil is wired to work in conjunction with the local user interface controller. Since the local user interface controller prevents the heating and cooling circuits from being energized at the same time, no additional power wiring is needed. We do recommend using the AUTO mode on the local user interface controller so it can switch from heating to cooling automatically. If using either the heat or cool only mode, the local user controller will **not** switch automatically.

No additional maintenance is required for the heating coil. To test the heating coil operation, set the local user interface controller on HEAT and set the temperature above the cellar temperature. The supply air temperature should rise above the return air temperature by an amount shown in the specifications.

Maintenance Schedule

Monthly

(or quarterly depending on experience with individual cellar) Check and drain trap – clean if needed.

- ✓ Check for noise or vibration.
- ✓ Check for short-cycling of the unit – turning on and off the compressor unit more than eight times/hour.

Yearly

(in addition to monthly)

- ✓ Check evaporator and condensing unit for dirt – use a vacuum with a brush attachment to clean the coils.
- ✓ Clean condensate pan under the evaporator coil by flushing. Be careful to keep the drain pans clear of any and all debris.
- ✓ Inspect cabinet for corrosion or rusting – clean and paint.
- ✓ Inspect for dirt buildup on or inside the unit. Clean unit by vacuuming or wiping it down.
- ✓ Check for loose insulation, fasteners, gaskets or connections.
- ✓ Check the wiring connections and integrity of cords.
- ✓ Examine ducts for any cracks or breach.
- ✓ Check fan and solenoid on humidifier.
- ✓ Replace humidifier pad (if used).

Troubleshooting



BEFORE PROCEEDING, READ AND UNDERSTAND THE SAFETY INFORMATION CONTAINED IN THE SAFETY SECTION OF THE WINE GUARDIAN MANUAL.

IMPORTANT

This section is intended as a diagnostic aid only. For detailed repair or parts replacement procedures, contact a qualified service company. Check the following table for some solutions before calling a service technician.

Typical start up problems

Possible Cause	Solution
Loose, improper or defective remote interface controller or humidistat cable	Check power, and remote interface controller or humidistat cable
Incorrect remote interface controller or humidistat (optional) settings	Check the remote interface controller and optional humidistat setup for the application
Changed settings on the remote interface controller	A common problem is not waiting long enough for the internal timers to complete their timed delay

Unit does not start up

Power Switch Light is Off	
Possible Cause	Solution
Switch not on No power to outlet Unit not plugged in	Turn on switch Check circuit breaker and wiring Plug in the unit

Power switch light is on and the remote interface controller light is off

Possible Cause	Solution
No power to remote interface controller	Check main control board for L.E.D. indication Check wiring for loose, broken or frayed connections Check wiring for proper splicing Remote interface controller may be faulty Remote Interface Controller may be faulty

Power switch light is on and the remote interface controller light is on

Possible Cause	Solution
Remote interface controller is not set up properly	Check remote interface controller set up in the guide Press fan ON switch to check evaporator fan only

<i>Unit is operating and blows evaporator air, but the supply air is not colder than the return air from the cellar</i>	
Possible Cause	Solution
Remote interface controller not set up properly	Check remote interface controller setup in the manufactures guide
Compressor not operating	High pressure switch open (button up) Alarm will appear on local user interface controller
Condenser airflow is blocked	Remove blockage Clean filter and coil (if needed) Head Pressure (HP) switch is open Reset HP switch See reset instructions on pg. 55

<i>Cellar temperature too cold (below 51 degrees) when unit is running</i>	
Possible Cause	Solution
Local user interface controller set too low on cooling	Reset local user interface controller to higher cooling temperature
Heating coil (optional) not operating	Check for remote interface controller rise across coil
Local user interface controller set too low on heating	Reset local user interface controller to higher heating temperature
Local user interface controller not controlling temperature	Local user interface controller mounted in improper location

<i>Cellar temperature too cold (below 51 degrees) when unit is not running</i>	
Possible Cause	Solution
Too much heat loss to adjacent spaces	Increase insulation around the ductwork Check and clean filter and coil Coil frozen – shut off unit for two hours
Cellar loads are too high	Install additional insulation

<i>Humidity too low or supply air is too cold, without optional humidifier</i>	
Possible Cause	Solution
Not enough evaporator airflow	Remove blockage in supply or return ductwork Check and clean filter and coil Coil frozen – shut off unit for two hours
Defective thermal expansion valve	If under warranty call for service If not under warranty call a refrigeration technician
Temperature set too cold	Raise temperature setpoint

<i>Humidity too low, without optional humidifier</i>	
Possible Cause	Solution
No moisture being added to cellar	Add Wine Guardian humidifier or a room humidifier

<i>Humidity too low, with optional humidifier</i>	
Possible Cause	Solution
Humidifier not operating	Check wiring for loose, broken or frayed connections Check humidistat set up Check for water flow and solenoid valve operation
Humidifier operating	Check for water being hot Check drip pad – replace if scaled No vapor barrier around cellar

<i>Humidity too high when unit is running but not cooling</i>	
Possible Cause	Solution
Compressor not operating	Check and reset high limit switch Clear blockage of condenser airflow
Ambient temperature is too high	Reduce temperature or draw condenser air from another space

<i>Humidity too high when unit is not running</i>	
Possible Cause	Solution
Unit needs to run to dehumidify	Run unit. Seal openings around doors (gasket and sweep)

<i>Humidity too high when unit is running and cooling</i>	
Possible Cause	Solution
Too much moisture in cellar	Poor vapor barrier installation Humidifier malfunction refer to the humidifier instructions Add dehumidifier to surrounding space

<i>Unit operates but the power switch light is not ON</i>	
Possible Cause	Solution
Bulb is burned out	Replace bulb
<i>Unit is leaking water</i>	
Possible Cause	Solution
Piping from unit to drain is trapped	Re-pipe to remove external traps
Trap plugged	Clean trap
Condensate pan plugged	Remove blockage and clean
Unit not level	Level with shims
<i>Unit is running properly, but the sound of the unit objectionable</i>	
Possible Cause	Solution
Noise is from airflow	Redirect airflow Add baffles Add insulated ductwork
Noise is from unit	Add sound baffle between unit and occupied

High Pressure Switch has Shut the Unit Down

The Wine Guardian unit has an automatic reset high pressure switch in the refrigeration system. This switch shuts the compressor and condenser down if the head pressure in the system is too high. It is intended to protect the compressor. Restricted airflow through the condenser is the most common reason for the pressure becoming too high. This can be caused by dust covering the filter or an obstruction blocking the airflow in the duct or grille. The high-pressure switch will reset itself automatically.

Instructions to Reset High Pressure Switch

1. Remove the top and side access panels at the condensing unit
2. Locate the high-pressure switch near the compressor
3. Push in the reset button until it locks into position.
4. Re-install top and side access panels

Advanced Troubleshooting

IMPORTANT

This section is intended for qualified refrigeration service technicians only. The technician should repeat all of the previous troubleshooting steps before taking action on these more technical solutions.

<i>Evaporator Coil is Freezing</i>	
Possible Cause	Solution
Charge too low	Check sight glass Check for leaks Add refrigerant
TXV malfunctioning	Repair or replace
<i>High pressure switch keeps tripping even after checking for obstructions and dirty filters/coils</i>	
Possible Cause	Solution
Condenser fan not operating	Repair or replace
Defective switch	Replace
<i>Unit cycles on and off more than 8 times/hr</i>	
Possible Cause	Solution
Local user interface controller malfunction	Check the remote interface controller guide for local user interface information
Low suction pressure	Check low pressure switch Check pressure and adjust superheat

High pitched or loud rubbing noise, clanking or vibration	
Possible Cause	Solution
Fans loose or malfunctioning	Repair or replace
Excessive compressor vibration	Replace
TXV malfunctioning	Repair or replace

Replacing the blowers

When replacing the fan or motor, replace the fan and motor as a unit. Do not remove the motor from the impeller wheel.

Contact and Warranty Information

Contact Information

Wine Guardian

7000 Performance Drive
North Syracuse, NY 13212
Toll free: (800) 825-3268

Service Department: press 3
Direct: (315) 452-7420
Service Department: ext. 7434

Normal business hours are 8 a.m. to 5 p.m. Eastern, Monday-Friday.
After hours, contact: (315) 391-8747

Web site: www.airinnovations.com
Email: info@airinnovations.com

Warranty and Warranty Procedure

The Wine Guardian unit serial number is noted on all packing lists and bills of lading and, along with the shipping date, is kept on file at Wine Guardian for warranty purposes. **All correspondence regarding warranty must include the model number and serial number of the unit involved.** Note that the warranty is null and void if the serial number on the unit or compressor is altered, removed or defaced. All inquiries or correspondence regarding warranty should be handled in accordance with the “Warranty” and directed to:

Wine Guardian

7000 Performance Drive
North Syracuse, New York 13212
Attn: Service Department
Toll Free: (800) 825-3268
Fax (315) 452-7420

This procedure includes but is not limited to:

- Obtaining authorization from Wine Guardian prior to incurring any charges for repair or replacement under warranty.
- Or returning prepaid within 30 days any and all defective parts.

Manufacturer's Warranty – U.S. and Canada Only

Warranty outside of the U.S. is determined by the country. Refer to your distributor for your Wine Guardian warranty.

GENERAL

Wine Guardian warrants, to the original buyer, its goods and all parts thereof to be free from defects in material and workmanship for a period of two (2) years from the date of invoicing assuming **NORMAL USE AND SERVICE**.

LIABILITY

Wine Guardian liability shall be limited to the repair or replacement (at its option) of any part, which, at our sole discretion, is determined to be defective. The purchaser shall pay all transportation costs. Additionally, if a malfunction occurs within the first year from the date of invoice, **Wine Guardian** will reimburse the reasonable cost of labor required for the repair or replacement provided authorization is obtained from one of our authorized representatives prior to incurring any labor charges.

LIMITATIONS OF LIABILITY

THESE WARRANTIES ARE MADE IN LIEU OFF ALL OTHER WARRANTIES EXPRESSED OR IMPLIED, INCLUDING ANY IMPLIED WARRANTY OF MERCHANTABILITY OR FITNESS FOR A PARTICULAR PURPOSE AND IN LIEU OF ANY OTHER OBLIGATION OR LIABILITY, INCLUDING LIABILITY FOR ANY INCIDENTAL OR CONSEQUENTIAL DAMAGES. **Wine Guardian** will not be responsible for any costs or liabilities whatsoever resulting from improper installation or service of its equipment. In the event that **Wine Guardian** or its distributors are found liable for damage based on any defect or nonconformity in the products, their total liability for each defective product shall not exceed the purchase price of such defective products. No person or representative is authorized to change these warranties or assume any other obligations or liabilities for **Wine Guardian** in connection with the sale of its systems.

INDEMNIFICATION

Purchaser agrees to indemnify, hold harmless and defend seller and its officers, directors, agents and employees from and against any and all claims, liabilities, costs and expenses arising out of or related to Purchaser's use of the goods, or in any way involving injury to person or property or accident occasioned by the goods sold by **Wine Guardian** to Purchaser.

FOREIGN GOVERNMENT AND INDIAN NATIONS

If Purchaser is a foreign government or an Indian nation, Purchaser hereby expressly waives its defense of sovereign immunity in the event of a dispute between Purchaser and **Wine Guardian** regarding this

invoice and Purchaser expressly acquiesces to the jurisdiction of the federal and state courts of the United States.

SEVERABILITY

If one or more of the provisions contained in this contract shall for any reason be held to be invalid, illegal or unenforceable in any respect, such invalidity, illegality or unenforceability shall not affect any provision of this contract, but this contract shall be construed as if such invalid, illegal or unenforceable provision had never been contained.

ADDITIONAL REQUIREMENTS

If a defect covered by the Warranty occurs, contact Wine Guardian for authorization to proceed with corrective action. Do not return any parts or incur any charges for which you expect to be reimbursed under this Warranty without receiving this authorization. If parts are replaced under this Warranty, the defective parts must be returned prepaid within 30 days. This warranty shall be null and void in its entirety if the Serial Number on the air conditioner or compressor is altered, removed or defaced.