

CEILING MOUNT
VERSION 3

OWNER'S MANUAL

Conforms to ANSI/UL Std 427

Certified to CAN/CSA Std C22.2 No. 120

We manufacture, test and certify 100% of our wine cooling units in the USA. By sourcing the best components and closely controlling our manufacturing processes, we can assure the highest-quality, lowest defect manufacturing rates in the industry.

Copyright © 2017. WhisperKOOL. All rights reserved.

WhisperKOOL copyrights this manual, the product design, and the design concepts, with all rights reserved. Your rights with regard to the hardware and manual are subject to the restrictions and limitations imposed by the copyright laws of the USA. Under copyright laws, this manual may not be copied, reproduced, translated, transmitted, or reduced to any printed or electronic medium or to any machine-readable form, for any purpose, in whole or in part, without the written consent of WhisperKOOL.

Every effort has been made to ensure that the information in this manual is accurate. WhisperKOOL is not responsible for printing or clerical errors.

WhisperKOOL reserves the right to make corrections or improvements to the information provided and to the related hardware at any time, without notice.

Vinothèque and WhisperKOOL are registered trademarks, and ECE is a trademark of WhisperKOOL. All rights reserved.

Mention of third-party products is for informational purposes only and constitutes neither an endorsement nor a recommendation. WhisperKOOL assumes no liability with regard to the performance or use of these products.

TABLE OF CONTENTS

| | |
|---|-----------|
| Introduction | 3 |
| Before You Start | 4 |
| Receiving & Inspecting the System | 5 |
| Quick Reference Guide | |
| Knockout Locations | 7 |
| Display Layout & Unit Specifications | 8 |
| Preparing the Wine Cellar | 9 |
| Liquid-Measuring Thermostat (Bottle Probe) | 13 |
| System Operation | 14 |
| Controller Functions | 16 |
| WhisperKOOL Troubleshooting Guide | 22 |
| Maintenance Schedule | 24 |
| Technical Assistance & Accessories | 25 |
| Installation Terms and Conditions | 26 |



WARNING



The evaporator unit (fan coil unit) must be insulated using the insulation blanket provided in accordance with this manual. Refer to the insulation blanket installation instructions.

Failure to follow the instructions provided will result in a poor vapor barrier, water damage, rust, and system corrosion which will void the warranty on your unit.

The evaporator unit (fan coil unit) must be insulated using fiberglass insulation (R19 or higher) in addition to the provided insulation blanket. This includes the cavity between the ceiling joists. A warm attic environment will reduce the capacity of the cooling system, as the system will absorb heat from the attic in addition to the heat load from the wine cellar. This, in effect, will significantly reduce the cooling system's ability to cool the wine cellar.

Failure to properly insulate the evaporator unit may cause condensation to form on the surface of the housing and water damage to the surrounding structure, the cooling unit, and possibly the wine cellar.

To avoid these issues, install the insulation kit and insulate the surface of the evaporator unit that is located outside of the wine cellar using fiberglass insulation.

***Additional insulation is required!**

INTRODUCTION

Customer Service

Thank you for purchasing a WhisperKOOL cooling system. We strive to provide the highest-quality products and the best possible customer service. If you have any questions about your system, please call us at 1-800-343-9463 or visit WhisperKOOL.com.

Using the Manual

This manual is intended to assist in the proper maintenance of the cooling system. In order to ensure the longevity of your cooling unit, the equipment should be installed as outlined in the technician's manual. It is also vital to establish a proper care and maintenance schedule. Please read and review this manual carefully and keep it for future reference.

What is the WhisperKOOL Cooling System?

The WhisperKOOL cooling system is a specialized refrigeration system designed for one purpose only: to maintain the optimal temperature and humidity levels conducive to the proper storage and aging of fine wines. This system produces minimal in-cellar noise and has the most lenient exhaust requirements. An exterior housing is required for outdoor condensing unit installations.

How Does the Cooling System Work?

Similar to the air conditioning systems used for homes, the evaporator unit and condensing units are installed in separate locations and are connected by a refrigerant line set. The evaporator portion is commonly installed in the wine cellar, with the condensing unit is located either outside or in a remote indoor location that is ventilated. An exterior housing is required for outdoor condensing unit installations.

Temperature Setting

The system is designed to maintain a cellar temperature of 55°F as long as the ambient temperature does not exceed 110°F.

WARRANTY REGISTRATION

In order to activate the warranty of your system, the verification and operational documentation must be completed by the certified refrigeration technician installing your system and submitted via mail, fax, or e-mail.

Mail to:
WhisperKOOL
ATTN: Warranty Registration
1738 E. Alpine Avenue
Stockton, CA 95205-2505
USA

Fax to:
209-466-4606

Scan and email to:
warranty@whisperkool.com

BEFORE YOU START

1-800-343-9463

1. **Inspect all components prior to installation.** If damage is found, please contact your distributor or WhisperKOOL Customer Service at 1-800-343-9463.
2. The evaporator unit **requires a dedicated 115V, 15-amp circuit.** The 4000 condenser **requires a dedicated 115V, 15-amp circuit.** The 8000 condenser **requires a dedicated 115V, 20-amp circuit.** Use a surge protector with the unit. **Do not use a GFI** (ground fault interrupter) line.
3. No communication cable is required between the evaporator and condensing unit.
4. You are **REQUIRED** to **install a drain line** to remove condensation from the evaporator unit.
5. ***The warranty is not active until a warranty checklist has been received, reviewed, and approved.***
6. The system is intended **for use in properly designed and constructed wine cellars.** Hire a professional wine storage consultant with a valid contractor's license to build your wine cellar.
7. WhisperKOOL requires that all split systems be installed by a certified HVAC-R technician only. NATE or equivalent is recommended.

If you encounter a problem with your WhisperKOOL system, please refer to the Troubleshooting Guide. If you have any further questions or concerns, or need assistance, please contact WhisperKOOL's Customer Service at 1-800-343-9463. Please be sure all testing has been completed prior to contacting Customer Service. Please have your results ready for your representative.

RECEIVING & INSPECTING THE SYSTEM

- Use caution when lifting and check package for damage.
- Lift only at the designated hand-hold locations on the shipping container, or fully support the unit from underneath. A shipment may include one or more boxes containing accessories.
- Before opening the container, inspect the packaging for any obvious signs of damage or mishandling.
- Write any discrepancy or visual damage on the bill of lading before signing.
- Allow the condensing unit to sit for 24 hours prior to start-up. The condensing unit can be placed in the installation location, piped and evacuated during this time.

Note: WhisperKOOL units are manufactured in the USA and tested prior to shipment.

- Review the packing slip to verify contents.
- Check the model number to ensure it is correct.
- Check that all factory options ordered are listed.

If any items listed on the packing slip do not match your order information, contact WhisperKOOL Customer Service immediately.

Check all shipped boxes for the following contents:

Evaporator Unit Box

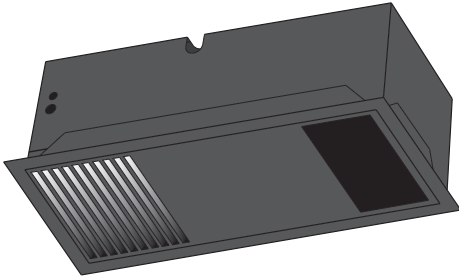

(1) Ceiling Mount evaporator unit

Documentation bag:

- Ceiling Mount Version 2 owner's manual
- Ceiling Mount Version 2 technician's manual
- R-134a split system warranty checklist

Accessory kit bag:

- Stainless steel probe (50 feet)
- KDT Plus display cable (50 feet)
- KDT Plus wall mount bracket assembly
- KDT Plus flush mount bracket assembly
- KDT Plus display assembly
- Flush mount template
- Evaporator installation hardware bag
- KDT Plus hardware bag

Ceiling Mount insulation blanket bag:

- Ceiling Mount insulation blanket

Single-piece mounting bracket

Condensing Unit Box

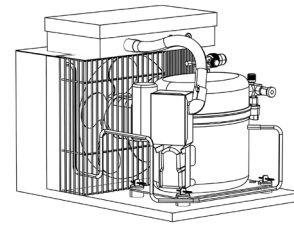

(1) Ceiling Mount condensing unit

Evaporator installation hardware bag:

- (12) 2½" Phillips wood screws
- (12) #8 ⅜" Phillips pan-head screws
- (1) Bypass plug
- (1) ¼" barbed coupling
- (2) 1⅜" L ½" conduit connectors

KDT Plus hardware bag:

- (1) 1⅛" OD grommet
- (2) ½" nylon hole plug
- (4) #6 x 1" Phillips zinc Type A screw
- (4) 8-10 x ⅞" blue plastic screw anchor

Condensing unit accessory kit:

- (1) Filter drier
- (1) Sight glass

Please leave the unit in its original box until you are ready for installation. This will allow you to move the product safely without damaging it. When you are ready to remove the product from the box, refer to the installation instructions.

TIP: Save your box and all packaging materials. They provide the only safe means of transporting/shipping the unit.

QUICK REFERENCE GUIDE

Bottom View

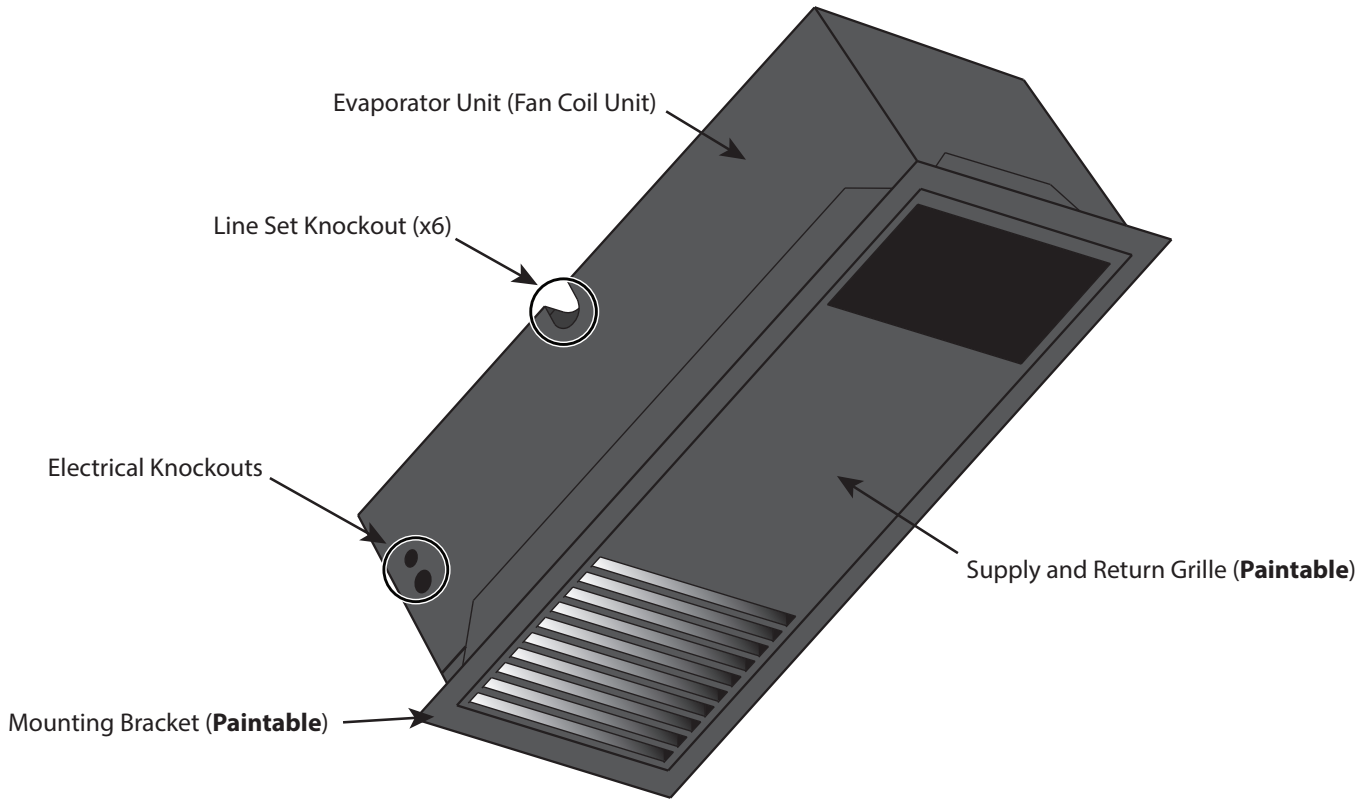

Top View

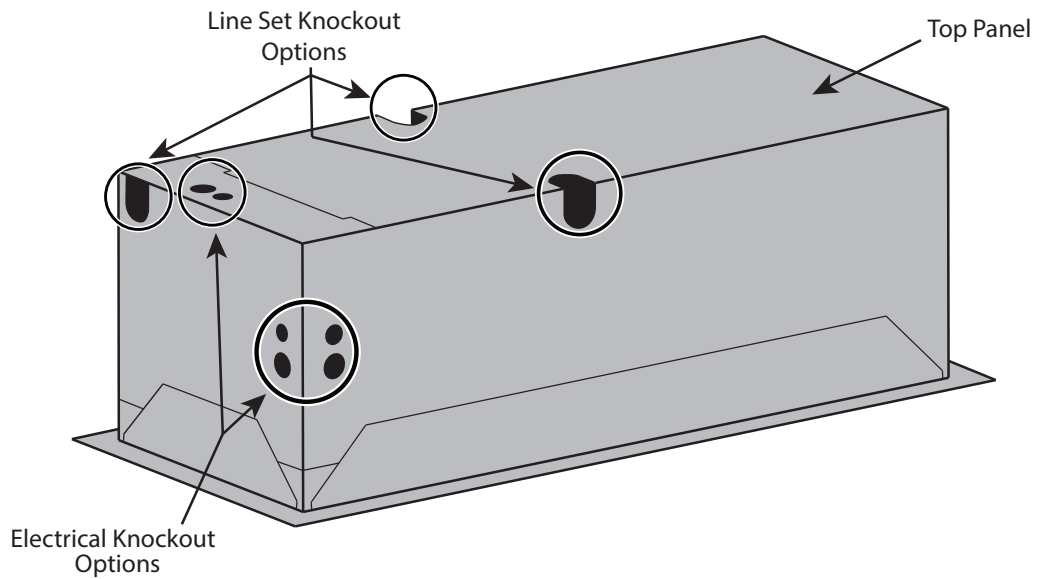

Note: The unit comes in black. The mounting bracket and front grille are paintable, enabling you to match your desired color.

KNOCKOUT LOCATIONS

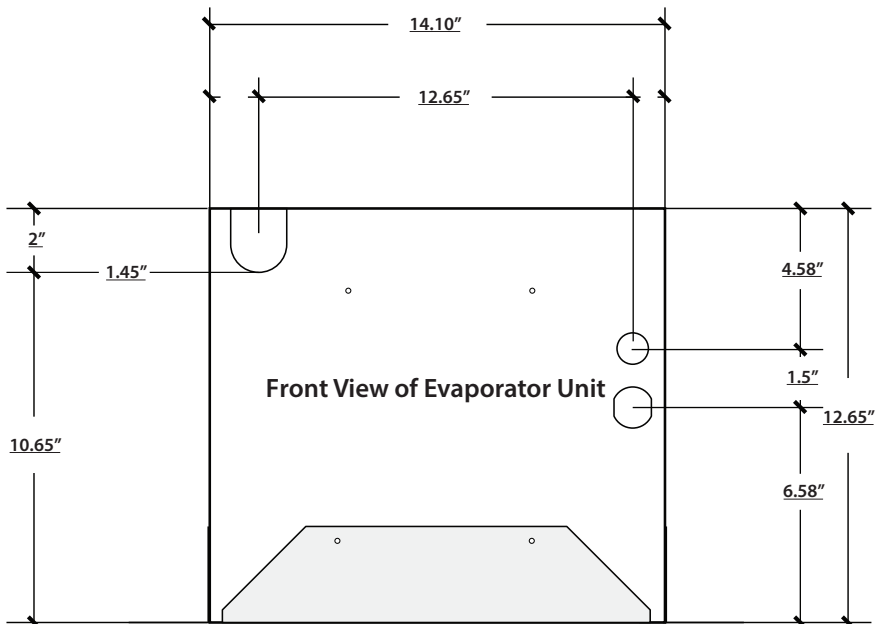
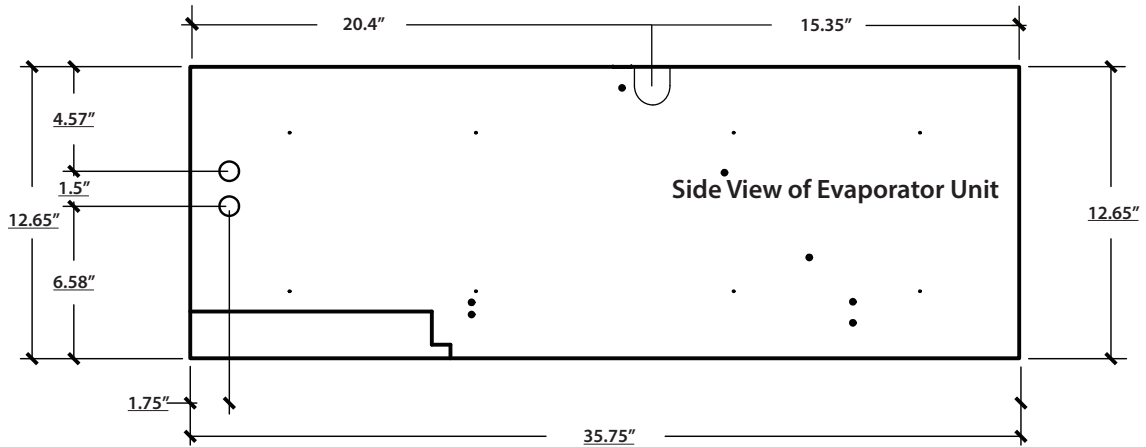
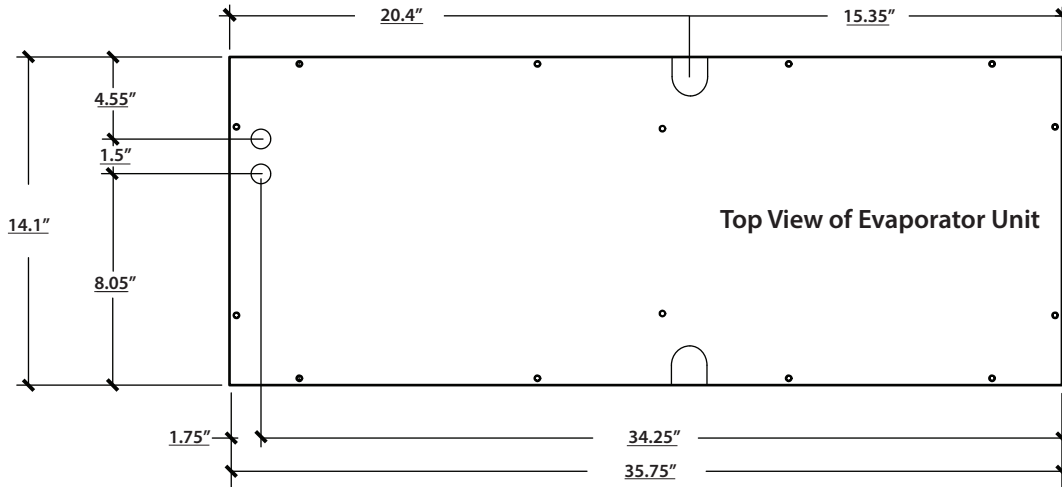

QUICK REFERENCE GUIDE

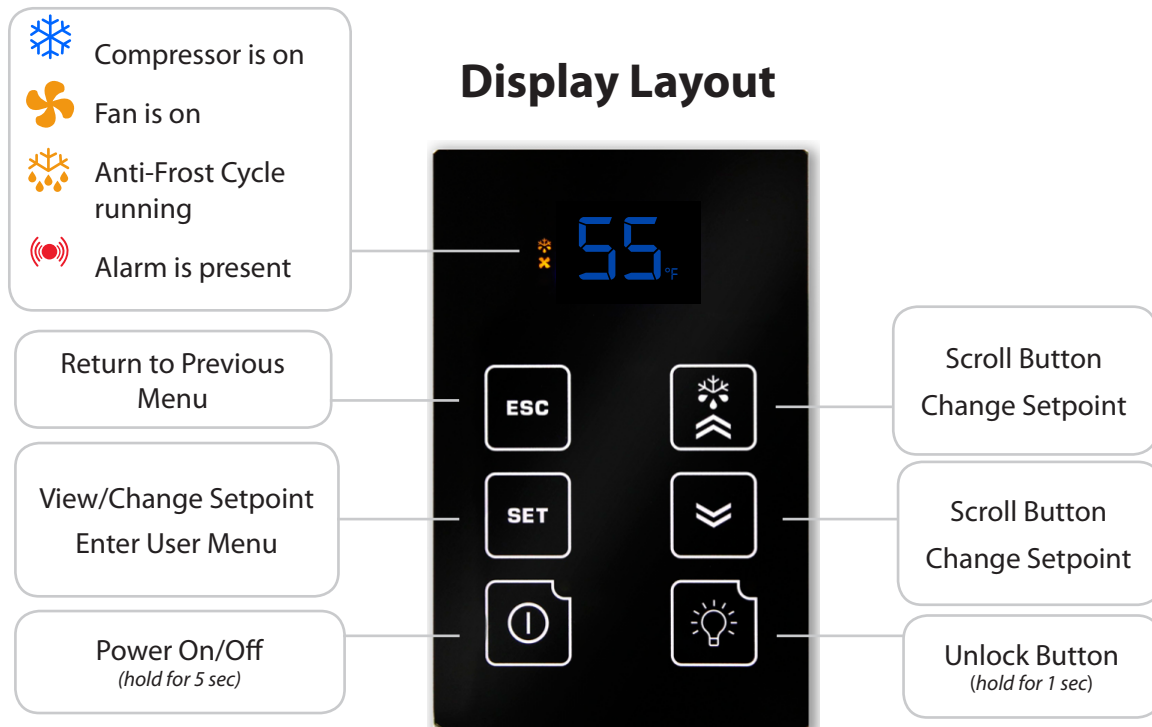

CEILING MOUNT 4000 SPECIFICATIONS

| Model | 4000 Evaporator (Fan Coil Unit) | 4000 Condenser (Air-Cooled Condensing Unit) |
|--|---|--|
| Cellar Size | Approx. 1000 cu. ft. when cellar is fully insulated and sealed with a proper vapor barrier* | |
| BTU/h w/85°F air entering condenser coil | 4000 | |
| Dimensions | 35.75"L x 14.5"W x 12.75"H | 16.08"L x 16.23"W x 12.61"H |
| Refrigerant | R-134a | |
| HP | 1.57 | |
| Voltage Rating | 115V (15-amp dedicated circuit required) | 115V (15-amp dedicated circuit required) |
| Weight (lbs) | 80 | 56 |
| Amps | Evaporator: 1 (running amps), compressor: LRA 43, RLA 8 | |
| Line Set | Liquid line: ¼" liquid line; suction line ½" (less than 50 ft.), ⅝" (more than 50 ft.) | |
| Drain Line | ¼" ID clear plastic tubing (not provided) | |
| Installation | Evaporator is installed in the cellar. Condensing unit can be installed up to 100 line feet from evaporator unit. | |
| Thermostat | Advanced digital display (50-ft. cable), liquid-temperature-measuring bottle probe (50-ft. cable) | |
| Temp. Delta | Can maintain a 55°F cellar temperature with up to 110°F condenser air intake temperature | |
| Warranty | Two-year limited warranty (parts and labor) | |

CEILING MOUNT 8000 SPECIFICATIONS

| Model | 8000 Evaporator (Fan Coil Unit) | 8000 Condenser (Air-Cooled Condensing Unit) |
|--|---|--|
| Cellar Size | Approx. 2000 cu. ft. when cellar is fully insulated and sealed with a proper vapor barrier* | |
| BTU/h w/85°F air entering condenser coil | 5254 | |
| Dimensions | 35.75"L x 14.5"W x 12.75"H | 16.08"L x 16.23"W x 12.61"H |
| Refrigerant | R-134a | |
| HP | 2.06 | |
| Voltage Rating | 115V (15-amp dedicated circuit required) | 115V (15-amp dedicated circuit required) |
| Weight (lbs) | 80 | 56 |
| Amps | Evaporator: 1 (running amps), compressor: LRA 50, RLA 9.3 | |
| Line Set | Liquid line: ¼" liquid line; suction line ½" (less than 50 ft.), ⅝" (more than 50 ft.) | |
| Drain Line | ¼" ID clear plastic tubing (not provided) | |
| Installation | Evaporator is installed in the cellar. Condensing unit can be installed up to 100 line feet from evaporator unit. | |
| Thermostat | Advanced digital display (50-ft. cable), liquid-temperature-measuring bottle probe (50-ft. cable) | |
| Temp. Delta | Can maintain a 55°F cellar temperature with up to 110°F condenser air intake temperature | |
| Warranty | Two-year limited warranty (parts and labor) | |

* Sizing the Unit to the Room

The specification chart will provide information on the unit's cooling capacity. There are circumstances in which a cellar design may require a larger unit due to preexisting design restrictions. Certain building materials such as glass, stone, or concrete may seem adequate but do not offer the insulation capacity required to maintain the optimum temperature for storing wine. We recommend purchasing a unit with a larger capacity to compensate for these design limitations. Undersized cooling units can lead to premature failure and/or prevent the system from reaching the desired set temperature. As a result, they are not covered under warranty.

PREPARING THE WINE CELLAR

The performance and life of your system is contingent upon the steps you take in preparing the wine cellar. Improperly preparing your enclosure or incorrectly installing your unit may cause unit failure, leaking of condensation, and other negative side effects.

IT IS HIGHLY RECOMMENDED THAT YOU OBTAIN THE ASSISTANCE OF A WINE STORAGE PROFESSIONAL.

Wine storage professionals work with licensed contractors, refrigeration technicians, and racking companies to build well-insulated, beautiful, and protective wine cellars. WhisperKOOL has put together some useful tips to assist in the installation process. Our recommendations are meant to act as a guide in the process of building a proper enclosure. Your intended location may have specific needs which we do not address.

Wall and Ceiling Framing

Build wine cellar walls using standard 2x4 or 2x6 boards and ceiling joists without violating local or state codes in your area. As a general rule, the thicker the walls and the higher the insulation value, the more consistent your cellar temperature will be.

Insulation

Insulation is **REQUIRED** in order to properly use WhisperKOOL products. It is vital that all walls and ceilings be insulated to keep the cellar temperature as consistent as possible during the summer and winter months. Standard fiberglass or rigid foam insulation is normally used in cellar construction; in some cases, "blown-in" insulation is used. The R-value, or quality of insulation, is determined by the rate at which heat passes through the insulation. The higher the R-value, the more resistant the insulation is to conducting heat, and the more consistent your wine cellar's temperature will be. Using higher R-values in insulation will lower your operating costs and WhisperKOOL unit run time. (R-13 is the recommended minimum; R-19 is preferred for interior cellar walls, and R-30 for ceilings and exterior walls.)

Vapor Barrier

Water vapor creates its own pressure, separate from the ambient air pressure, and will intrude into colder/drier areas. A vapor barrier is **REQUIRED** in order to prevent the intrusion of water vapor and maintain the correct cellar temperature and humidity. It is recommended that 6-millimeter plastic sheeting be applied to the warm side of the cellar walls. The vapor barrier must also be applied to the outside walls and ceiling. If it is impossible to reach the outside, then the plastic must be applied from within the cellar. The most common method is to wrap the entire interior, leaving the plastic loose in the stud cavity so the insulation can be placed between each stud. All of the walls and ceiling must be wrapped in plastic for a complete vapor barrier.

In areas of high humidity, such as Southern and Gulf States, the vapor barrier will prevent infiltration of warm moist air. The moist air can cause mold to form, and standing water in drain pans promote microbial and fungal growth that cause unpleasant odors and indoor air quality problems. If mold is found, remove it immediately and sanitize that portion of the unit.

NOTE: High humidity significantly increases the heat load on the cooling system.

Any break in the vapor barriers (cut, nail hole, over-lapping, etc.) will cause a moisture leak and must be sealed. The electric conduit is a "duct" for vapor to travel in. The conduit should be caulked and sealed on the warm air end.



Unobstructed Airflow

Unobstructed airflow to and from the system is critical for the system's overall performance and lifespan. A minimum of 3 feet of clearance around the unit is crucial (5 feet is ideal). The air blown by the fans needs to circulate and either dissipate or absorb heat from the space. The system will operate more efficiently with a greater amount of air to exchange.

Note: Avoid attempting to camouflage the unit. This will restrict airflow, and thus the system's ability to work efficiently.



Door and Door Seal

An exterior-grade (1 $\frac{3}{4}$ ") door must be installed as a cellar door. It is very important that weather stripping is attached to all four sides of the doorjamb. A bottom "sweep" or threshold is also required. The door must have an excellent seal to keep the cool cellar air from escaping the cellar. If the door is not sealed properly, the cooling system may run continuously, shortening its operational lifespan.

In cases where glass doors are used and the room size is close to the recommended system size, the next larger size WhisperKOOL system should be used. This will compensate for the insulation loss due to the lower insulation rating of glass.

Ventilation

The necessity of dissipating heat away from the condensing unit is critical to the system's performance and cannot be overstated. As the system operates and cools, a greater amount of heat is generated on the condensing side of the system. Adequate ventilation is required in order to dissipate heat away from the condensing unit. If ventilation is inadequate, the exhaust will heat the area or room and adversely affect the system's ability to cool. In some cases, it may be advisable to install a vent fan to dissipate heat within the exhaust area on the condensing side of the system. However, you must have a fresh air inlet as well.

Note: If you are unsure whether you have adequate ventilation in your installation location, please contact us to assess your specific installation at support@whisperkool.com or 1-800-343-9463.

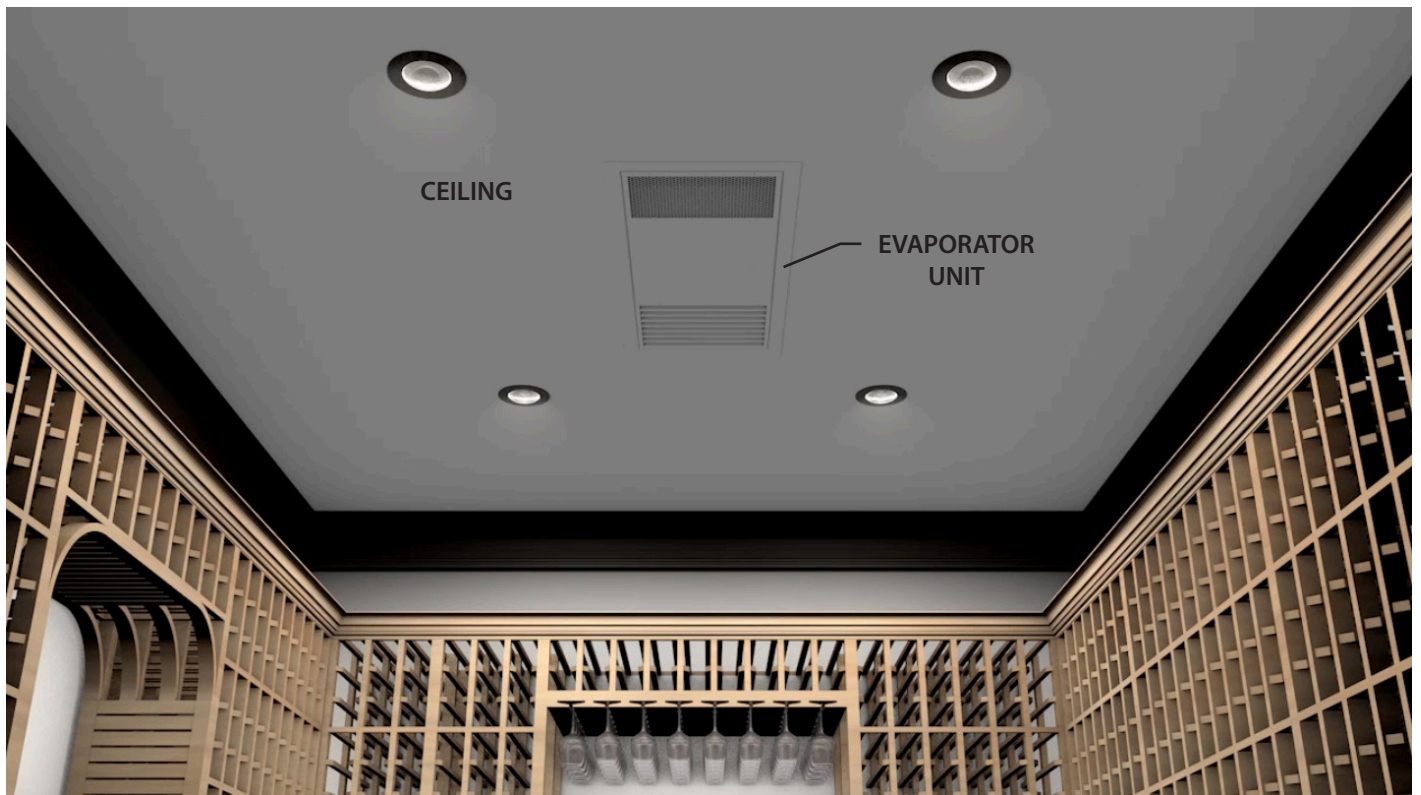

Note: The unit comes in black. The mounting bracket and front grille are paintable, enabling you to match your desired color.

Ambient Temperature Factor

The cooling system has the ability to cool a wine cellar efficiently to 55°F as long as the ambient temperature of the area to which it is exhausting does not exceed 110°F. Therefore, you the condensing unit to exhaust in a space which will not exceed 110°F, allowing for proper dissipation of the heat exhausted by the condensing unit. Without proper heat dissipation the system will not have the capacity to keep the wine at a desirable 55°F.



WARNING! Allowing your system to operate in high ambient temperatures for extended periods of time will greatly decrease the life of your system and void your warranty. The cooler the temperature of the air entering the condenser coil, the more cooling capacity the system has. The less heat gain through the common wall, the lower the consumption of electricity.



LIQUID-MEASURING THERMOSTAT SYSTEM (BOTTLE PROBE)

WhisperKOOL cooling units come with a liquid-temperature-measuring thermostat. The self-calibrating probe contains a sensor chip, which communicates back and forth with the thermostat. This results in a consistent temperature setting and accuracy. Wine should be kept at a very precise, controlled temperature and humidity. By measuring the liquid temperature rather than air, the unit will operate 75–80% of the time.

Setting up the Bottle Probe:

1. Locate an empty wine bottle.
2. Fill it 75% full with room-temperature tap water.
3. Place bottle probe securely into bottle as seen in Figure 1.
4. Place bottle off to the side of the unit in your wine cellar, with the probe level.
5. To ensure a consistent temperature, place bottle probe approximately three (3) feet away from the air output and not in the flow of the air.

It is recommended that the bottle be placed in a central location of your wine cellar. Avoid pulling too much on the probe cord. It may become disconnected resulting in limited functionality of the unit.

Note: The thermostat can be set between 50–70°F.

Remember: The unit operates based on the temperature of the water.

Do not be misled by thermostats reading air temperature. The air temperature in the cellar will be cooler than the liquid temperature of the wine while it is reaching the optimum balanced temperature.

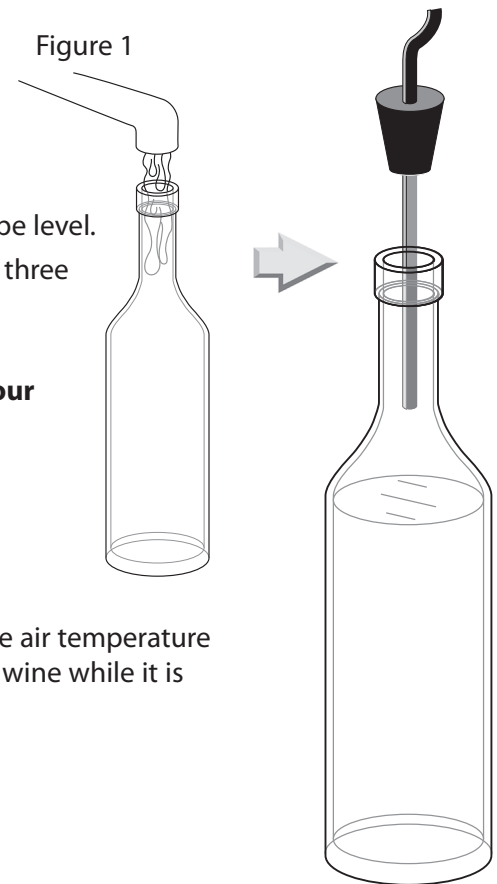

SYSTEM OPERATION

Initial Start-Up

When the unit is plugged in and power is sent to the controller, a beep will sound, confirming that the controller is getting power. All LEDs on the display will blink three times. Three dashes will then appear on the screen. All display LEDs will then blink three times. Once the controller has gone through the initial startup process, and all LEDs have cycled, the home screen will be displayed.

Setpoint

The setpoint is preset at the factory to 55°F. It can be adjusted by the customer between 50–70°F in one-degree increments.

Indoor Fan Operation

The indoor fan will run when the controller is calling for cooling and turn off once the cooling cycle has ended. During the cooling cycle, the system will remove some relative humidity from the cellar. Some of the humidity that was removed can be reintroduced into the cellar by adjusting the “fan on” and “fan off” functions. (The cooling system is not equipped with a humidifier and does not add humidity.)

The FOF cycle should be shortened first. This will reduce the amount of time that the fan remains off following a cooling cycle. When the unit has completed a cooling cycle, the compressor and the condenser fan will turn off, but the indoor fan will continue to run for whatever length of time the customer has set. The Fon function may then be lengthened to allow the fan to run longer and reintroduce moisture from the evaporator coil back into the wine cellar.

For more information about fan settings, refer to the User Menu on page 19.

Anti-Short Cycle

The Anti-Short Cycle ensures that the unit will remain off for a period of five minutes after the unit has reached the setpoint. This allows the pressure in the refrigeration system to equalize prior to starting the compressor.

Once the solenoid relay is de-energized, the controller must wait five minutes before reenergizing the relay. This prevents the compressor from repeatedly turning off and on. If the unit is calling for cooling during this time, the compressor icon will blink, indicating that cooling is needed but the controller is waiting for the Anti-Short Cycle delay.

Anti-Frost Cycle

When the evaporator probe senses a temperature of 26°F for a duration of one minute, an Anti-Frost Cycle will be initiated. This will shut down the compressor, allowing the evaporator fan to run and melt any frost accumulation on the coil. While the Anti-Frost Cycle is running, “dEF” will be displayed on the screen. The compressor will remain off until the evaporator coil reaches 40°F, or for a maximum of one hour. The unit will then return to normal operation.

Operation in Low Ambient Temperatures

The condensing unit comes equipped with a LAC (Low Ambient Control). The LAC is a three-way modulating valve that responds to discharge pressure. When the discharge pressure falls below the valve’s dome pressure, the valve modulates open to the discharge port which allows discharge gas to bypass the condenser. Mixing the discharge gas with the liquid creates high pressure at the condenser outlet, reducing the flow and causing liquid to backup in the condenser. Flooding the condenser reduces the area available for condensing. This reduction in condenser surface area results in a rise in condensing pressure during cold ambient conditions.

The condensing unit controller comes preset from the factory with the cut-in pressure at 25psi and the cut-out pressure at 15psi. During low ambient temperatures (40°F or below), it will be necessary to adjust the cut-in pressure to 10-15psi (15psi preferred) and the cut-out to 5psi to ensure compressor startup. See page 45 of the technician’s manual for instructions on adjusting the cut-in and cut-out pressures of the condensing unit.

Digital Display

The display is designed to give the user the ability to adjust the setpoint, Fon/FOF parameters, and other settings. (See User Menu on page 19 for more details.) The bottle probe temperature is displayed by default. “dEF” will be displayed during an Anti-Frost Cycle. The bottle probe and evaporator probe temperatures can be accessed by pushing the SET button and scrolling through “Pb1” (bottle probe) and “Pb2” (evaporator probe). The light button may be used as an unlock button.

Safety Features

In the event of a faulty bottle probe, the compressor will cycle off for 10 minutes and on for 40 minutes. “E1” will be displayed on the screen.

The evaporator unit comes equipped with a condensate pump to remove the condensation produced by the evaporator coil. The reservoir is mounted in the internal drip tray and will kill power to the unit if the condensate level rises too high.



If the drain line is obstructed or the pump fails for some reason, and the water level in the drip tray gets too high, the unit will not operate until the water in the internal drip tray drops back below the proper level.

In this event the controller will send an alarm to the display. (The alarm message, EA, can be viewed in the User Menu’s ALr folder.)

Alarms

See “Alarm Codes” in the Controller Functions chart.

DISPLAY LAYOUT

 Compressor is on  Alarm is present

 Fan is on

 Anti-Frost Cycle running

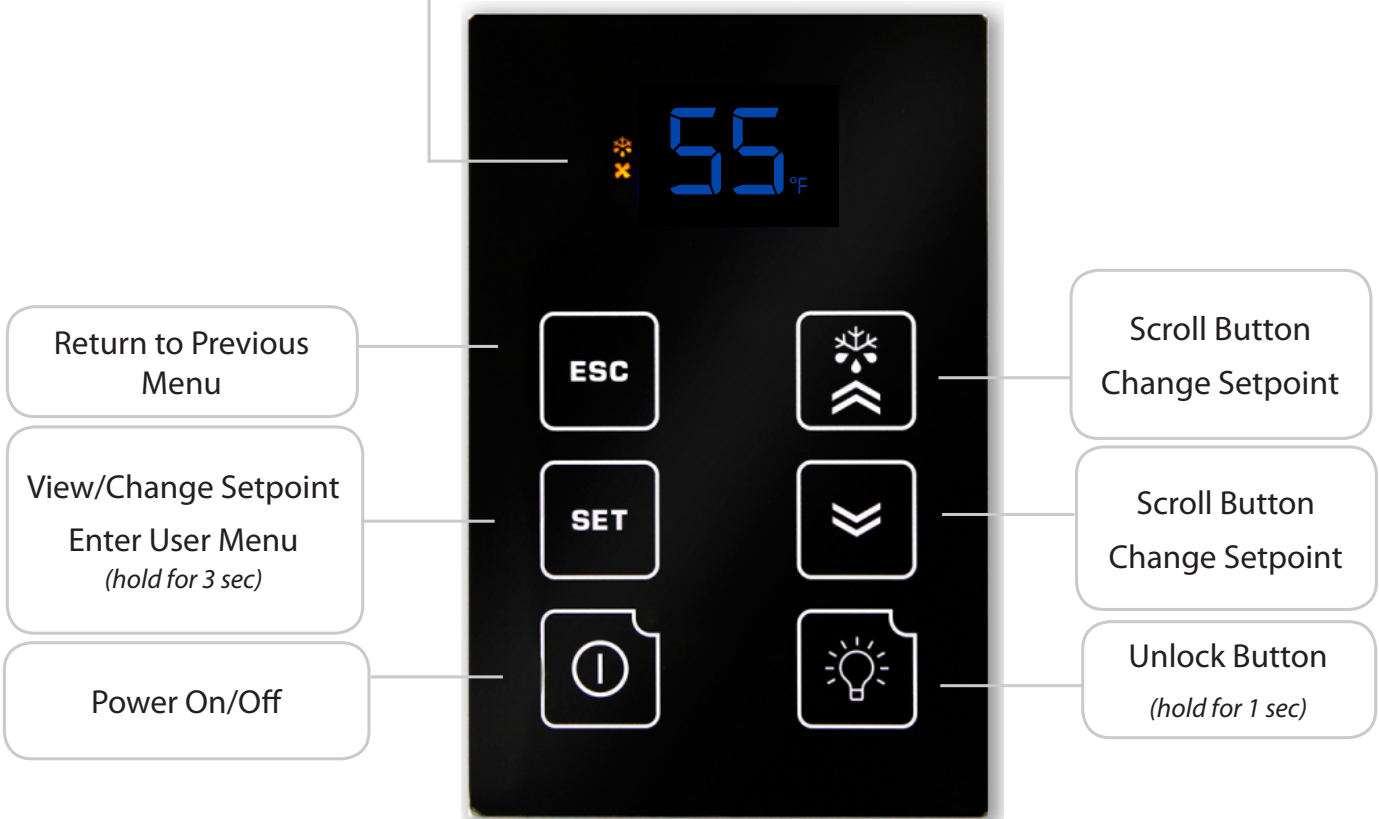

Return to Previous Menu

View/Change Setpoint
Enter User Menu
(hold for 3 sec)





Power On/Off

Scroll Button
Change Setpoint





Scroll Button
Change Setpoint

Unlock Button
(hold for 1 sec)



CONTROLLER FUNCTIONS

| Button | Normal Functions | | | | | | | | |
|---|---|-----|----------|------------|--------------|------------|-----------------------------------|------------|-----------------------------|
| INITIAL STARTUP | When the unit is plugged in and power is sent to the controller, a beep will sound, confirming that the controller is getting power. All LEDs on the display will blink three times. Three dashes will then appear on the screen. All display LEDs will then blink three times. Once the controller has gone through the initial startup process, and all LEDs have cycled, the home screen will be displayed. | | | | | | | | |
| UNLOCKING THE DISPLAY | Press and hold any button for one second to unlock the display. (A white LED will appear in the top left corner of the button being pressed.) A beep will sound, signifying that the display is unlocked. NOTE: The display must be unlocked before any button functions become available. | | | | | | | | |
| ON/OFF  | To turn the unit ON, press and hold the ON/OFF button until the red LED turns OFF. To turn the unit OFF, press and hold the ON/OFF button until the red LED turns ON. | | | | | | | | |
| UP/DOWN  | The up and down arrows are used to navigate through menus and adjust parameters such as setpoint, Fon/FOF, etc. | | | | | | | | |
| SET  | <ul style="list-style-type: none"> To change the setpoint, press the SET button. When "SEt" is displayed on the screen, press the SET button once more. Use the UP and DOWN ARROW buttons in order to change the value until the desired setpoint is reached. The SET button allows you to view the setpoint, evaporator temperature, bottle temperature, alarms, and the hidden menu. Press the SET button once. "SEt" will be displayed. Press the UP or DOWN ARROW buttons to scroll through ALr, Pb1, or Pb2. <table border="1" data-bbox="467 1199 1511 1367"> <thead> <tr> <th>Set</th> <th>Setpoint</th> </tr> </thead> <tbody> <tr> <td>ALr</td> <td>Alarm folder</td> </tr> <tr> <td>Pb1</td> <td>Liquid (bottle probe) temperature</td> </tr> <tr> <td>Pb2</td> <td>Evaporator coil temperature</td> </tr> </tbody> </table> <ul style="list-style-type: none"> Press the SET button again to view any of these values. Hold the SET button for approximately 5 seconds to enter the User Menu. (More information about the User Menu is available on page 19.) Other parameters in the User Menu which are not available for adjustment include: idF, rEL, and LAN. | Set | Setpoint | ALr | Alarm folder | Pb1 | Liquid (bottle probe) temperature | Pb2 | Evaporator coil temperature |
| Set | Setpoint | | | | | | | | |
| ALr | Alarm folder | | | | | | | | |
| Pb1 | Liquid (bottle probe) temperature | | | | | | | | |
| Pb2 | Evaporator coil temperature | | | | | | | | |
| ESC  | This button confirms changes made to parameters such as the setpoint and returns you to the previous menu. | | | | | | | | |
| LIGHT  | The light function is not in use. However, this button can still be used to unlock the display. | | | | | | | | |

ICON GLOSSARY

| Icon | Meaning |
|--|---|
| SNOWFLAKE  | <p>Blinking: The unit is calling for cooling, but must wait five minutes before restarting the compressor. This five-minute delay serves as an Anti-Short Cycle for the compressor's protection.</p> <p>Constant: The unit is in cooling mode and the condensing unit is running.</p> |
| DRIPPING SNOWFLAKE  | <p>The unit is undergoing an Anti-Frost Cycle. While the Anti-Frost Cycle is running, "dEF" will be displayed on the screen. See System Operation page for further details.</p> |
| FAN  | <p>The evaporator fan is running.</p> |
| ALARM  | <p>The alarm icon is shown when the unit encounters an issue that needs attention. Alarm codes are explained on the following page. All temperature-related alarms are blocked for the first 10 hours after the unit is plugged in to allow the system to stabilize and acclimate to the new environment.</p> |

WHISPERKOOL CONTROLLER ALARM CODES

| Code | Cause | Solution |
|---|--|--|
| The following alarm codes will be displayed on the screen along with the alarm icon.  | | |
| E1 | Bottle probe is not connected | Attach bottle probe to circular connector |
| | Faulty bottle probe connection | Locate faulty bottle probe connection by inspecting all wiring connections between the bottle probe and the circuit board. The two-pin connector for the bottle probe should be connected to the CPB/PB1 terminal on the circuit board. If it is not connected, plug it in. If a faulty connection has been identified, correct the issue or contact customer service for further assistance. NOTE: The E1 code will not appear in the alarms menu. It will be permanently displayed on the screen. |
| | Defective bottle probe | Replace the bottle probe |
| E2 | Faulty evaporator probe connection | Locate faulty evaporator probe connection by inspecting evaporator probe wire. The two-pin connector for the evaporator probe should be connected to the CPB/PB2 terminal on the circuit board. If it is not connected, plug it in. |
| | Defective evaporator probe | Replace the evaporator probe |
| E7 | No communication between keypad and circuit board for 60 seconds | Verify that the display cable is connected to the keypad and the circuit board and is not damaged, frayed, or kinked. If problem persists, contact Customer Service for troubleshooting information. |
| E10 | Clock battery is dead | Replace battery NOTE: A dead clock battery will not affect the operation of your cooling unit. |
| The following alarm codes will not be displayed on the home screen. However, the alarm icon will be displayed in the event of an alarm. The alarms can be viewed in the Set Menu's ALr folder.  | | |
| EA | Unit is not draining properly | <ol style="list-style-type: none"> 1. Check to see that the unit is level; if not, level it 2. Verify that the drain line is not clogged; if so, clear obstruction 3. Ensure that the condensate pump is operating 4. Verify wire connection at D.I. port of circuit board NOTE: If the drain line is obstructed or the pump fails for some reason, and the water level in the drip tray gets too high, the unit will not operate until the water in the internal drip tray drops back below the proper level. NOTE: If the unit loses power (due to a power outage or being manually unplugged), the condensate pump may need to be reset. To do this, disconnect and reconnect the black cables on the condensate pump. |
| AH1 | The bottle probe is sensing a temperature that is 4°F above the setpoint | <ol style="list-style-type: none"> 1. Allow time for the wine to reach the desired temperature 2. Ensure that the cellar is sealed properly 3. Verify that the bottle probe is calibrated correctly (refer to the User Menu on the following page) 4. Verify that the unit is sized correctly for the cellar |
| AL1 | The bottle probe is sensing a temperature that is 4°F below the setpoint | <ol style="list-style-type: none"> 1. Make sure the unit is not in cooling mode (the snowflake icon will not be illuminated) 2. Add heat to the room until the wine reaches the desired temp 3. Verify that the bottle probe is calibrated correctly (refer to the User Menu on the following page) |
| Ad2 | The Anti-Frost Cycle ended on time-out | <ol style="list-style-type: none"> 1. Check the evaporator coil for ice buildup. Unplug the unit and allow the coil to thaw before restarting. 2. Make sure the room to which the unit is exhausting is not below 60°F 3. If the unit repeatedly goes into Anti-Frost Cycles (one per minute), call Customer Service for more troubleshooting information |

USER MENU

The User Menu is accessed by **pressing and holding the SET button for 3 seconds**. Use the UP and DOWN ARROW buttons to navigate to desired parameters. Press the SET button again to view these parameters. Press the UP and DOWN ARROW buttons to adjust a parameter.

The following parameters are available in the menu:

| Parameter | Description |
|---|--|
| Fdc - humidity enhancement | This parameter is measured in minutes, and is preset at the factory to 1. An increase in this parameter will increase the humidity enhancement of your cellar. This parameter should not be adjusted to zero. Adjustments should be made in increments of 5, with a maximum of 15 and a minimum of 1. After making any adjustments to humidity enhancement, you should wait a minimum of 3 days before making any additional adjustments. This will allow sufficient time for the cellar to acclimate to the new setting. |
| FOF - "fan off" | This setting controls how long the fan stays off after the setpoint has been reached. It is preset to 15 minutes. This setting should not be adjusted, as most properly constructed wine cellars retain an ample amount of humidity during the "fan off" cycle. If, however, you wish to decrease the duration of the "fan off" cycle (in order to increase the wine cellar's relative humidity), you can adjust this setting in the User Menu. |
| Fon - "fan on" | The "fan on" time is preset to zero minutes. This keeps the relative humidity of the wine cellar at a stable level. If, however, you wish to raise the relative humidity of your wine cellar, you can increase the duration of the "fan on" cycle in increments of five (5, 10, or 15 minutes). After making any adjustment to the "fan on" cycle, you should wait a minimum of 3 days before making any additional adjustments. This will allow sufficient time for the cellar to acclimate to the new setting. |
| CA1 - bottle probe (Pb1) calibration | CA1 - bottle probe (Pb1) calibration: You may use this parameter to calibrate the bottle probe to a known temperature. This parameter can be adjusted between -12°F and 12°F. For example, if the bottle probe temperature is 58°F, and the known temperature is 55°F, you can set the CA1 parameter to -3°F to match the known temperature. |
| PA2 - installer menu | This menu is only accessible using a password and is not available for adjustment. |
| dOA - digital input | This setting determines which of the unit's components will be activated or deactivated when a certain electrical relay is activated or deactivated in response to an alarm. The controller comes pre-programmed with a factory setting of 2. 2 = activates the compressor and fans 5 = disables the compressor and fans NOTE: Setting the dOA to any number other than 2 or 5 will prevent the unit from operating properly. |

Emerson[™] Electronic Unit Controller

Quick setup and troubleshooting guide

Adjusting Low Pressure Settings

Hold DOWN and SET simultaneously for 3 seconds to enter menu (PSI light will flash)  + SET

Cycle through menu options – UP/DOWN  

Select function – SET 

Adjust value – UP/DOWN  

Store function - SET 

Exit menu - UP and SET  + SET



Low Pressure Cut-In





Low Pressure Cut-Out

Accessing Alarm Code Information

Press and release ALARM 

Cycle through menu options – UP/DOWN  

Press SET to see number of alarms 

Press SET again to return to menu options 

Exit menu - UP and SET  + SET

| Alarm | Description |
|-------|-----------------------------------|
| PoF | Keypad locked |
| Pon | Keypad unlocked |
| P1 | Suction probe failure |
| P2 | Condenser probe failure |
| P3 | DLT probe failure |
| HA | High condenser temperature alarm |
| dLt | DLT temperature alarm |
| dLL | DLT lock alarm |
| HP | High pressure trip alarm |
| HPL | High pressure trip lock-out alarm |
| EE | Module Failure |
| LOC | Number of lock-outs |

Note: After 15 seconds of inactivity the controller will revert to the default display.

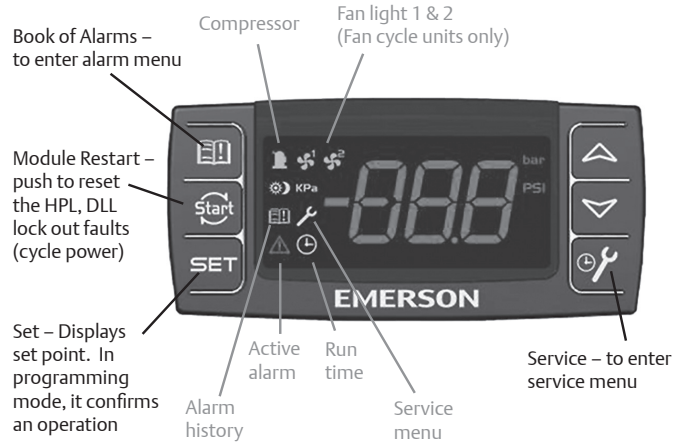



When light is on, feature or component is on or active

Accessing Service Menu

Hold SERVICE for 3 seconds 

Cycle through menu options – UP/DOWN  

Press SET to see number of alarms 

Press SET again to return to menu options 

Exit menu - UP and SET  + SET

| Code | Description |
|------|--------------------------------|
| StH | CompressorStarts –1000 -999999 |
| StL | Compressor Starts –0 -999 |
| CHH | CompressorHours -1000 -999999 |
| CHL | Compressor Hours -0 -999 |
| F1H | Fan 1 Hours -1000 -999999 |
| F1L | Fan 1 Hours-0 -999 |
| F2H | Fan 2 Hours -1000 -999999 |
| F2L | Fand 2 Hours -0 -999 |

Example: If StH=12 and StL=500, the total number of compressor starts=12,500

For more information visit EmersonClimate.com/ElectronicUnitController or call 1-888-367-9950



| Display | Likely Causes | Other Possible Causes |
|--|---|---|
| Controller display remains blank after applying power | <ul style="list-style-type: none"> Unit power not properly applied - check for proper applied voltage Power cable harness not plugged in properly or securely into the back of the controller – check connections | <ul style="list-style-type: none"> Power cable miswired – inspect cable, replace if needed Electrical assembly miswired – trace wiring diagrams |
| Controller displays correctly, but the green compressor light is off and the compressor is not running | <ul style="list-style-type: none"> Jumper cable not plugged in properly or securely into the back of the controller – check connections Controller is currently above the cut-in setting – check cut-in and cut-out settings | <ul style="list-style-type: none"> Jumper cable miswired – inspect cable, replace if needed |
| Controller displays correctly and the green compressor light is on and the compressor is not running | <ul style="list-style-type: none"> Power cable harness not plugged in properly or securely into the back of the controller – check connections | <ul style="list-style-type: none"> Power cable not wired to the contactor or compressor correctly, check wiring Power cable miswired – inspect cable, replace if needed |
| Controller flashes “135” or “P1” | <ul style="list-style-type: none"> Current system pressure is above 135 PSIG – wait for system to pull down Green harness not plugged in properly or securely into the back of the controller – check connections Cable not connected properly with the pressure transducer – check connections | <ul style="list-style-type: none"> Transducer cable miswired – inspect cable, replace if needed Damaged transducer – inspect transducer, replace if needed |
| Controller flashes “P2” on a unit with fan cycling | <ul style="list-style-type: none"> Green harness not plugged in properly or securely into the back of the controller – check connections | <ul style="list-style-type: none"> Transducer cable miswired – inspect cable, replace if needed Check condenser temperature sensor resistance values against table in AE-1376, Section 8 |
| Controller flashes “P2” on a unit without fan cycling after replacing a controller | <ul style="list-style-type: none"> Controller not programmed properly – check parameters in the advanced menu | |
| Controller flashes “P3” on a unit with DLT | <ul style="list-style-type: none"> Jumper cable not plugged in properly or securely into the back of the controller – check connections | <ul style="list-style-type: none"> Jumper cable miswired – inspect cable, replace if needed Faulty DLT temperature sensor – check the discharge line temperature sensor resistance values against table in AE-1376, Section 8 |
| Controller flashes “P3” on a unit without DLT after replacing a controller | <ul style="list-style-type: none"> Controller not programmed properly – check parameters in the advanced menu | |
| Fans not running on a fan cycling unit and the fan lights are not on | <ul style="list-style-type: none"> Condensing temperature is currently below the fan cut-in Condensing temperature sensor not properly installed – check installation | <ul style="list-style-type: none"> Transducer cable miswired – inspect cable, replace if needed Faulty temperature sensor - check condenser temperature sensor resistance values against table in AE-1376, Section 8 |
| Fans not running on a fan cycling unit and the fan lights are on | <ul style="list-style-type: none"> Power cable harness not plugged in properly or securely into the back of the controller – check connections | <ul style="list-style-type: none"> Power cable miswired – inspect cable, replace if needed Electrical assembly miswired – trace wiring diagrams |
| Controller flashes “HP” at power-up | <ul style="list-style-type: none"> Jumper cable not plugged in properly or securely into the back of the controller – check connections High pressure switch is seeing above the cut-out pressure For a replacing an -00 controller, ensure that the jumper cable is the latest revision. It should have a blue wire in the harness. See replacement instructions for more details | <ul style="list-style-type: none"> Jumper cable miswired – inspect cable, replace if needed Faulty fixed Hp switch – inspect switch, replace if needed |
| Controller flashes “HP” or “HPL” | <ul style="list-style-type: none"> System operation causing high discharge pressures, check system operations | <ul style="list-style-type: none"> Bad high pressure switch, verify system pressure when the pressure switch trips. See AE-1376, Section 7.2 for more details |
| Controller flashes “DLT” or “DLL” | <ul style="list-style-type: none"> System operation causing high discharge line temperatures, check system operations | <ul style="list-style-type: none"> Faulty temperature sensor - check DLT sensor values against table in section 8 See AE-1376, Section 7.1 for more details |
| Controller flashing “HPL” or “DLL” | <ul style="list-style-type: none"> System operation causing high discharge pressures (HPL) or high discharge line temperatures (DLL) repeatedly, check system operations To clear an “HPL” or “DLL” lockout, you can hold the Restart button for 3 seconds twice, or cycle power to the unit. If using the reset button, the alarm condition will have to clear (DLT temperature drops or Hp switch resets), and any minimum off time will need to complete (5 minutes for the fixed Hp switch) | |

EmersonClimate.com/ElectronicUnitController

2013ECT-46 (9/13) Emerson is a trademark of Emerson Electric Co. ©2013 Emerson Climate Technologies, Inc. All rights reserved.

EMERSON. CONSIDER IT SOLVED.™

WHISPERKOOL TROUBLESHOOTING GUIDE

| Unit has ice forming on the evaporator unit | |
|--|--|
| Possible cause | Solution |
| Evaporator filter or coil is dirty | Remove the filter and wash it, then clean the coil with a vacuum. If coil is very dirty, use a spray bottle with a small amount of liquid dish detergent or coil cleaner. Spray coil, let set for five minutes, then flush with fresh water. |
| There is something blocking the supply and/or return air | Remove blockage |
| The evaporator fan is not turning on | Call a service tech to troubleshoot |
| The evaporator unit has not gone through an Anti-Frost Cycle yet | Check the coil for surface ice. Melt with blow drier until coil is warm to the touch. Soak up water with a towel. |
| If evaporator unit continues to ice | Observe ice formation pattern. If only part way up the coil face, the system could be low on refrigerant. If all the way up, the coil may be dirty or airflow is blocked. |
| Unit does not run/power up | |
| Possible cause | Solution |
| Evaporator Unit is not plugged in | Make sure the unit is plugged into an outlet |
| Power switch not on | Turn unit on by pressing the power button on the control |
| Line voltage rating is incorrect for the system | Check line voltage to make sure there is 110V-120V |
| Bottle at setpoint | Lower setpoint |
| Thermostat not calling for cooling | Lower setpoint |
| Faulty thermostat or wiring | Call Customer Service at 1-800-343-9463 |
| Cellar temperature is too warm | |
| Possible cause | Solution |
| The temperature of the room to which the condensing unit exhausts exceeds 110°F | Intake temperature needs to drop below 110°F |
| The system is undersized for the cellar | Order correct size system |
| There is something blocking the supply and/or return air on the evaporator unit or the condensing unit | Remove air flow obstruction |
| Evaporator unit is mounted too low in the cellar | Relocate unit so the distance from the ceiling and top of the unit is no more than 18" |
| One or more of the fans is not turning on | Please contact the installing technician to troubleshoot |
| Compressor is not turning on | Please contact the installing technician to troubleshoot |
| Compressor keeps cycling on overload | Make sure all fans are working and there is no airflow obstruction |
| Poor seal around door or other areas requiring a seal (around the unit, wall joints, etc.) | Make sure there are no air gaps around the door. If door seal is damaged, replace it. |
| Setpoint too high | Lower the setpoint |
| Evaporator coil is frosted or iced up | Observe ice formation pattern. If only part way up the coil face, evaporator unit could be low on refrigerant. If so, contact your installing technician to assist with troubleshooting. |
| System runs constantly | |
| Possible cause | Solution |
| Leaky door seal or poorly insulated cellar | Fix leaky door seal and insulate cellar |

| Unit leaks water | |
|---|--|
| Possible cause | Solution |
| Evaporator unit is not level | Evaporator unit should be level on the wall to prevent leaking |
| Drain line clogged or kinked | Check drain line to make sure water can flow freely |
| Drain is clogged, preventing water from escaping | Disconnect drain and clear it out; check drain for blockage |
| Drain line does not have a downward slope | Fix drain line so there is a downward slope from the unit to the drain |
| Coil is iced, causing drain pan to freeze and water to overflow | Melt ice with blow drier. Soak up with a towel. |
| Condensate pump needs to be reset | Disconnect and reconnect the black cables attached to the pump |

| Unit runs but does not cool | |
|------------------------------------|---|
| Possible cause | Solution |
| Lack of air flow | Make sure fan is unobstructed and that the evaporator filter, evaporator coil, and condenser coil are clean and free of debris |
| System undersized | Contact Customer Service at 1-800-343-9463 |
| Compressor is overheating | Shut system off for 1 hour to allow compressor to cool. Turn back on and check for cooler air flow out. If compressor runs, check for and clean condenser coil as possible cause of compressor overheating. If problem repeats, contact you installing technician to assist with troubleshooting. |

| Evaporator fan runs but compressor does not | |
|--|--|
| Possible cause | Solution |
| Running an Anti-Frost Cycle | 1) If the system is maintaining the correct cellar temperature and there is a dripping snowflake symbol illuminated on the control, the system is going through an Anti-Frost Cycle. No action is required. 2) If the system is not maintaining the correct cellar temperature, this may be due to a dirty evaporator filter or coil. 3) Call installing technician to troubleshoot, as the system may be low on charge or require an adjustment to the TXV. |
| Compressor and/or starting components faulty | Please contact the installing technician to troubleshoot |
| System may be performing the WHM function | Allow cooling system to revert back to cooling mode |
| Compressor may have overheated | Shut system off for 1 hour to allow compressor to cool. Turn back on and check for cooler air flow out. If compressor runs, check for and clean condenser coil as possible cause of compressor overheating. If problem repeats, contact your installing technician to assist with troubleshooting. |

| Compressor runs but evaporator fan does not | |
|--|--|
| Possible cause | Solution |
| Faulty fan motor | Please contact the installing technician to troubleshoot |
| Faulty controller | Please contact the installing technician to troubleshoot |

| Compressor short cycles | |
|---|--|
| Possible cause | Solution |
| Evaporator unit blows on bottle probe | Move bottle probe to a more central location |
| System low on refrigerant charge | Please contact the installing technician to troubleshoot |
| Condensing fan motor/capacitor faulty | Please contact the installing technician to troubleshoot |
| Compressor and /or starting components faulty | Please contact the installing technician to troubleshoot |

| Humidity in cellar too low | |
|-----------------------------------|--|
| Possible cause | Solution |
| Not enough moisture | Purchase and place a humidifier (or a decorative fountain) in cellar |

MAINTENANCE SCHEDULE

| | |
|------------------|--|
| Monthly | <ol style="list-style-type: none">1. Check coils2. Check for unusual noise or vibration3. Check the drain line to see if it is above the waterline (if draining into a vessel) |
| Quarterly | <ol style="list-style-type: none">1. Use a vacuum with brush attachment to clean coils; be careful not to crush coil fins when cleaning2. Change duct filter if the system is ducted |
| Annually | <ol style="list-style-type: none">1. Inspect for corrosion2. Check wiring connections and integrity of cords3. Pour a 50/50 bleach solution into the drain line every spring |

TECHNICAL ASSISTANCE

WhisperKOOL Customer Service is available Monday through Friday from 6:00 a.m. to 4:00 p.m. Pacific Standard Time.

The appointed customer service representative will be able to assist you with your questions and warranty information more effectively if you provide them with the following:

- The model and serial number of your WhisperKOOL system(s).
- Location of unit and installation details, such as ventilation, ducting, construction of your wine cellar, and room size.
- Photos of the cellar and installation location may be needed.

Contact WhisperKOOL Customer Service

1738 E. Alpine Ave
Stockton, CA, 95205
www.whisperkool.com

Email: support@whisperkool.com

Phone: 209-466-9463

US Toll Free: 1-800-343-9463

Fax: 209-466-4606

Visit www.emersonclimate.com/electronicunitcontroller for online brochures, bulletins, instruction videos, and general product information.

Download the Copeland Mobile App on your mobile device for additional troubleshooting and technical information.



ACCESSORIES FOR COOLING UNITS

WhisperKOOL offers accessories to enhance and customize your wine cooling unit:

Condensate Pump Kit

The condensate pump kit automatically removes water that drips out of the evaporator unit's drain line. The pump is controlled by a float/switch mechanism that turns the pump on when approximately 2¼" of water collects in the tank, and automatically switches off when the tank drains to approximately 1¼". The condensate pump kit allows the excess condensate to be pumped up to 20 feet away from the unit.

Exterior Housing

If the cooling unit is installed outside, it will need protection from sun, wind, and rain. The exterior housing protects the condensing unit portion of the split system from the elements when installed outdoors.

Accessories can be purchased at www.whisperkool.com

WhisperKOOL Product Terms and Conditions
Including Product Limited Warranty And Product Installation Requirements
For WhisperKOOL Split System Series

ATTENTION: PLEASE READ THESE TERMS OF USE CAREFULLY BEFORE INSTALLING YOUR WHISPERKOOL COOLING SYSTEM. INSTALLING YOUR WHISPERKOOL COOLING SYSTEM INDICATES THAT YOU ACCEPT AND AGREE TO EACH OF THE TERMS AND CONDITIONS SET FORTH HEREIN ("TERMS OF USE"). IF YOU DO NOT ACCEPT THESE TERMS OF USE, YOU RISK VOIDING YOUR WARRANTY AND ASSUMING ADDITIONAL REPAIR AND REPLACEMENT COSTS.

1. Purchase of a WhisperKOOL Cooling System assumes that the Purchaser ("End User") fully accepts and agrees to the Terms and Conditions set forth in this document. The Terms and Conditions of Sale and Owner's Manual are shipped with each unit and, if another copy is needed, replacement copies can be downloaded from the company website (whisperkool.com) or by contacting WhisperKOOL directly for a new copy. WhisperKOOL reserves the right, in its sole discretion, to change its Terms and Conditions at any time, for any reason, without notice.

2. WhisperKOOL Product Installation and Limited Warranty

- A. Purchaser of the product must arrange for the product to be installed by a certified HVAC/R technician in accordance with procedures set forth by WhisperKOOL and described in the WhisperKOOL Owner's Manual.
- B. The HVAC/R technician installing the product must complete the designated portion of the Split Startup Checklist and provide licensing or certification identification number information to assist in the warranty registration process.
- C. Purchaser must return the completed Split Startup Checklist to WhisperKOOL within thirty (30) days of installation of Product. The Split Startup Checklist must be approved by WhisperKOOL to activate the Limited Warranty. If the Split Startup Checklist is approved, Purchaser will be sent activation approval documents and will start receiving the benefits of the Limited Warranty throughout the warranty period. If the Split Startup Checklist is incomplete, Purchaser will be informed they have five days to complete the Split Startup Checklist and re-submit to WhisperKOOL. The Split Startup Checklist will be reviewed again, and if denied, Purchaser will be informed that they have 10 business days for corrective action. Failure to register the Product may result in loss of warranty.
- D. Purchaser is responsible for the full costs of installation and any additional parts required for the proper and complete installation of the product.
- E. For Split Systems returned to WhisperKOOL in accordance with the terms and conditions of the Limited Warranty, WhisperKOOL warrants against defects in material and workmanship as follows:
 1. **LABOR** — For a period of two (2) years commencing on the date of purchase, WhisperKOOL will, at its option and discretion, reimburse up to \$250 to the End User for cost incurred for servicing, repairing, removing or installing warranty parts. Invoice for service must be forwarded to WhisperKOOL for assessment and processing. The Split System warranty is invalid if there is attempted repair by anyone other than an HVAC/R technician approved by WhisperKOOL to service the Product.
 2. **PARTS** — For a period of two (2) years commencing on the date of purchase, WhisperKOOL will supply, at no charge, new or rebuilt replacement parts in exchange for defective parts. Replacement parts are warranted only for the remainder of the original warranty period.
 3. **FREIGHT** — For a period of two (2) years commencing on the date of purchase, if after WhisperKOOL approved evaluation the original Product failure is determined to be the cause of a manufacturers defect, and not the cause of an installation error or other cause, WhisperKOOL will cover at its option, freight for the replacement parts or Product.

The following part or cause of failure is not the responsibility of WhisperKOOL:

- Improper voltage supply
- Line set with screw connectors (high end and low end)
- Leaks found at the braze points when performing pressure check
- Unit that has been charged incorrectly

- Incorrect tubing diameter used on line set
- A unit that has been wired incorrectly
- Valve stem on condenser side
- Improper installation of P-Trap
- Lack of P-Trap (if required)
- Condensers that are installed outdoors or in elements that would affect operation without proper cover or housing. (Housing is available from Manufacturer).

Product Warranty Limitations and Exclusions.

1. This limited warranty does not cover cosmetic damage caused during installation, damage due to acts of God, commercial use, accident, misuse, abuse, negligence, or modification to any part of the Product. Delivery and installation of the Product, any additional parts required, as well as removal of the Product if warranty work is required, are all at the sole cost, risk and obligation of the End User.
2. This limited warranty does not cover damage due to improper installation or operation or lack of proper maintenance of the Product, connection of the Product to improper voltage supply, or attempted repair of the Product by anyone other than a technician approved by WhisperKOOL to service the Product.
3. This limited warranty does not cover any Product sold "AS IS" or "WITH ALL FAULTS."
4. Product that has been replaced during warranty period does not extend the warranty period past the original date of purchase.
5. This limited warranty is valid only in the continental United States. Sales elsewhere are excluded from this warranty.
6. Proof of purchase of the Product in the form of a bill of sale, receipted invoice or serial number, which is evidence that the Product is within the Limited Warranty Period, must be presented by the End User to WhisperKOOL in order to obtain limited warranty service.
7. This limited warranty is void if the factory applied serial number has been altered or removed from the Product.
8. This limited warranty is voided if installed in an enclosure of insufficient design that does not follow the Product installation requirements stated herein and in the owner's manual.
9. Removing the rivets from the Product's unit housing without prior authorization from WhisperKOOL voids this limited warranty.
10. The End User must first contact WhisperKOOL Customer Service by telephone (at 1-800-343-9463) prior to attempting service on any Product still under the limited warranty; else the limited warranty is voided.
11. This limited warranty does not cover Product being concealed by, but not limited to, vegetation, fabric, shelving, mud, snow, or dirt. Product must not be painted or limited warranty will be void.
12. This limited warranty does not cover exposure to corroding environments such as, but not limited to, petroleum and gasoline products, cleaning solvents, caustic pool chemicals, and marine air.
13. This limited warranty does not cover any cause not relating to Product defect.
14. THE REPAIR OR REPLACEMENT OF THE PRODUCT AS PROVIDED UNDER THIS LIMITED WARRANTY IS THE EXCLUSIVE REMEDY OF YOU, THE END USER, AS WELL AS ANYONE ELSE IN THE CHAIN OF TITLE OF THE PRODUCT, DOES NOT START A NEW LIMITED WARRANTY TIME PERIOD, AND IS IN LIEU OF ALL OTHER WARRANTIES (EXPRESS OR IMPLIED) WITH REGARD TO THE PRODUCT. IN NO EVENT SHALL WHISPERKOOL BE LIABLE FOR INCIDENTAL, CONSEQUENTIAL, SPECIAL OR CONTINGENT DAMAGES FOR BREACH OF ANY EXPRESS OR IMPLIED WARRANTY ON THIS PRODUCT. THE IMPLIED WARRANTIES OF MERCHANTABILITY
15. AND FITNESS FOR A PARTICULAR PURPOSE ARE HEREBY EXPRESSLY DISCLAIMED. Some states do not allow the exclusion or limitation of incidental or consequential damages, or allow limitations on how long an implied warranty lasts, so the above limitations or exclusions may not apply to you. This limited warranty gives you specific legal rights, and you may have other rights, which vary from state to state.
16. Failure of the End User to comply with all of the Product Installation Requirements, Maintenance Requirements and End User Requirements may, at WhisperKOOL's sole discretion, void this limited warranty.
17. No one has any authority to add to or vary the limited warranty on this Product.

3. Maintenance Requirements

The End User is responsible for checking the coils on the condenser unit and vacuuming them every three months to maintain them free of debris. It is the End User's responsibility to clean off any accumulated dust, lint, or other debris from the front and rear intake grills; failure to do this on a regular basis will restrict the airflow and may affect the Product's ability to function properly. Periodically cleaning the Product's vents will help assure maximum cooling efficiency. The drain tube must also be checked and kept clean and free of debris and mold to maintain proper performance.

Mold is a natural living organism in the environment. It exists in the air in the form of microscopic spores that move in and out of buildings through doors, windows, vents, HVAC systems and anywhere else that air enters. Once it is discovered, mold must be addressed quickly and appropriately. Delayed or improper treatment of mold issues can result in costly and reoccurring repairs. If the End User suspects a mold problem, it is always best to hire a qualified and experienced mold remediation specialist.

4. Additional End User Costs And Responsibilities

Terms and conditions for replacing the Product that is being evaluated for limited warranty.

1. After evaluation by a certified HVAC/R technician and the Product is found to be irreparable in the field, contact WhisperKOOL Customer Service to arrange for replacement under the warranty guidelines. When a claim for warranty is submitted for a condenser skid, the End User must purchase a new condenser skid from WhisperKOOL at retail price. Upon installation of the new condenser skid by a certified HVAC/R Technician, the HVAC/R Technician must complete the Installation Checklist and End User must submit the Installation Checklist to WhisperKOOL Customer Service for approval. The original condenser skid must be returned within 21 days to WhisperKOOL for failure analysis. If the Installation Checklist is approved and the failure is evaluated as defective and not installation error or other reason, the End User will be refunded for the cost of the replacement skid.
2. If the Product failure is evaluated and it is determined that it is an installation error or other reason, all costs, including shipping will be the responsibility of the End User.

The following items are not covered under any warranty and are the sole responsibility of the End User:

- A. End Users should satisfy themselves that the Product they are purchasing is suitable for their particular needs and requirements, and thus no responsibility will be placed with WhisperKOOL for the End User's decisions in this regard.
- B. End Users must assure that the product is installed by a certified HVAC/R technician. Failure to do so will result in Voiding the Limited Warranty.
- C. It is the End User's responsibility to secure safe haven/storage for ANY AND ALL items that are being kept and stored in the End User's wine cellar, including any Product. WhisperKOOL takes no responsibility for the safety and preservation of the aforementioned items in the event that the environment becomes unsuitable to maintain a proper storage environment.
- D. End User is responsible for initial installation costs, including, but not limited to, labor costs and the cost of any additional parts necessary to complete the installation.
- E. End User is responsible for all costs incurred for the installation and/or removal of the Product, or any part thereof, unless such cost has been agreed by WhisperKOOL to be a warranty repair prior to the work being performed.

5. Sales and Use Tax

WhisperKOOL only collects California sales tax for orders shipped within the State of California; WhisperKOOL does not collect sales tax for orders shipped to other states. However, the Purchaser and the End User may be liable to the taxing authority in their state for sales tax and/or use tax on the Product. The Purchaser and the End User should each check with their state's taxing authority for sales and use tax regulations.

6. Customer Service and Troubleshooting

WhisperKOOL's customer service department is available to answer any questions or inquiries for End Users regarding a WhisperKOOL Product, as well as to assist in performing basic troubleshooting, Monday through Friday, from 6:00 a.m. to 4:00 p.m. PST, at telephone number 1-800-343-9463. WhisperKOOL reserves the right to have a certified, WhisperKOOL-approved, HVAC/R technician go on site and inspect the product if the initial trouble shooting warrants further investigation. WhisperKOOL Corporation is located at 1738 East Alpine Avenue, Stockton, California 95205.

7. Request for Product Evaluation and Repair Under Warranty

SPLIT SYSTEM FIELD SERVICE WARRANTY POLICY: This Policy is to clarify what falls under Warranty Service and what becomes the responsibility of the Owner. WhisperKOOL (“manufacturer”) strives to provide our customers with a superior Product and we back our Product with a Two Year Limited Warranty. Please review the WhisperKOOL Product Terms and Conditions including Product Limited Warranty and Product Installation Requirements to ensure you have a complete understanding of our Policy and coverage of your Split System.

ARBITRATION: Any disputes arising out of or in connection with the installation and warranty of the Split System shall be referred to and finally resolved by a WhisperKOOL approved Independent Certified HVAC/R Technician. The evaluation of the Technician on all issues or matters of identifying the responsible party (WhisperKOOL or Installing Technician) shall be determined in a written report. This report will be made available to all concerned parties. If discovered under warranty, WhisperKOOL will assume the financial responsibility under their warranty guidelines. If the report finds the Owner’s Installer as the responsible party, WhisperKOOL will provide all documentation to the customer to substantiate the findings. This will include the Invoice from the Independent Certified HVAC/R Technician and the written report of the findings. The Owner will become responsible for payment directly to WhisperKOOL for all charges incurred for repairs (labor, parts and shipping costs) on the Split System.

8. Miscellaneous Terms and Conditions

- A. Return Policy. All return inquiries must be made within thirty (30) calendar days of the original purchase of a Product and are subject to a twenty five percent (25%) restocking fee. Shipping costs are not refundable and the Purchaser is responsible for all return shipping costs (including customs fees and duties, if applicable).
- B. Security Interest. WhisperKOOL retains a security interest in each Product until payment in full.
- C. Construction and Severability. Every provision of these Terms and Conditions shall be construed, to the extent possible, so as to be valid and enforceable. If any provision of these Terms and Conditions is held by a court of competent jurisdiction to be invalid, illegal or otherwise unenforceable, such provision will, to the extent so held, be deemed severed from the contract of sale between Purchaser and WhisperKOOL, and all of the other non-severed provisions will remain in full force and effect.
- D. Governing Law/Choice of Forum. The laws of the State of California (without regard for conflicts of law) shall govern the construction and enforcement of the these Terms and Conditions of Sale (Sections 1 through 9 inclusive, including Product Limited Warranty And Product Installation Requirements), and further these Terms and Conditions of Sale shall be interpreted as through drafted jointly by WhisperKOOL and Purchaser. Any dispute will be resolved by the courts in and for the County of San Joaquin, State of California, and all parties, WhisperKOOL, Purchaser and End User, hereby irrevocably submit to the personal jurisdiction of such courts for that purpose. No waiver by WhisperKOOL of any breach or default of the contract of sale (including these Terms and Conditions of Sale) concerning a Product will be deemed to be a waiver of any preceding or subsequent breach or default.
- E. Correction of Errors and Inaccuracies. These Terms and Conditions may contain typographical errors or other errors or inaccuracies. WhisperKOOL reserves the right to correct any errors, inaccuracies or omissions, and to change or update these Terms and Conditions, at any time without prior notice.

9. Questions, Additional Information And Technical Assistance

- A. Questions. If you have any questions regarding these Terms and Conditions or wish to obtain additional information, contact us via phone at 1-800-343-9463 or please send a letter via U.S. Mail to:

Customer Service
WhisperKOOL Corporation
1738 E Alpine Ave
Stockton, CA 95205

E-mail: support@whisperkool.com
Web: www.whisperkool.com

- B. Technical Assistance. WhisperKOOL Customer Service is available Monday through Friday from 6:00 a.m. to 4:00 p.m. PST. The Customer Service representative will be able to assist you with your questions and warranty information more effectively if you provide them with the following:
 - 1. The model and serial number of your WhisperKOOL UNIT.
 - 2. The location of the system and installation details, such as ventilation, construction of your wine cellar, and room size.

Model _____ **Serial Number** ____ _

Installed by _____ **Date** _____

*Whisper***KOOL**[™]

WhisperKOOL
1738 E. Alpine Ave
Stockton, CA 95205
1-800-343-9463
www.whisperkool.com